

# **DiaLog Elite**

---

## ***User Guide***

Publish Date: May 17, 2013  
Document Version 6.0



# Table of Contents

Table of Figures.....	3
Chapter 1: Description.....	1
What's Changed in this Version.....	1
Overview.....	1
Alarm capabilities.....	1
Control capabilities.....	1
Expandable.....	2
Communications capabilities.....	2
Chapter 2: Installation and Setup.....	3
Overview.....	3
What is the Installation Process?.....	3
Unpacking the Equipment.....	3
Operating Environment.....	3
Mounting the Equipment.....	3
Fiberglass NEMA Enclosure.....	4
Main Power Connection.....	6
AC Wire Size.....	6
Proper Grounding.....	6
Optional DC Power Connection.....	7
Strain Relief.....	7
Power Fuse.....	7
Phone Line Connection.....	7
Input and Output Cards.....	7
Installing I/O cards.....	8
Digital Input Cards.....	9
Analog Input Wiring.....	11
Relay Wiring.....	14
<i>Turning on the Elite</i> .....	14
<i>Verifying Battery Backup Connection</i> .....	16
Chapter 3 - Quick Start.....	17
Default Values.....	17
Quick Programming Steps.....	18
Step 1 – Configure the System Identification.....	18
Step 2 – Configure the Phone numbers for list 1.....	18
Step 3 – Setup Digital Inputs (skip if not using digital inputs).....	18
Step 4 – Setup Analog Inputs (skip if not using analog inputs).....	18
Step 5 – Compute motor run times (optional).....	19
Step 7 – Save Programming.....	19
Testing the system.....	20
Chapter 4: Operation.....	21
Overview.....	21
How to use the Keypad.....	22
Programming Keys when Calling in.....	23
Local Key summary.....	24
How to Enter Text for Names.....	25
RUN Mode Operations.....	26
Viewing the Display.....	26
Automatic Alarm Screen.....	27
How alarms are presented via LEDs.....	27
System Channels.....	29
Physical Channel Numbering.....	30
Modbus Channel Numbering.....	30
RUN Mode screens.....	31
Acknowledging Alarms.....	33
From the Front Panel.....	33

Remotely when Called.....	33
Acknowledge input channel .....	33
Remotely when Calling In .....	33
How to Prevent the DiaLog Elite from Calling Out (Disarming) .....	34
Chapter 5: PROGramming Mode from the Keypad.....	35
Overview .....	35
Display – Selecting a menu item .....	35
Display – Changing a setting .....	35
System Wide Settings.....	36
Program Phone Settings.....	38
Program Channel Settings .....	39
Analog Inputs .....	39
Relay Outputs .....	41
Digital Inputs .....	42
Relay List Setup.....	43
Relay Operations .....	43
Chapter 6: Modbus RTU Master.....	45
Overview .....	45
Initializing the Modbus Master Interface.....	45
Modbus Master Channel Setup.....	46
Modbus Master Port Setup .....	47
Mapping Elite Channels to Modbus Registers.....	47
Chapter 7: Modbus RTU Slave.....	49
Overview .....	49
Serial Port Settings .....	49
Modbus Slave Port Setup.....	50
Modem Settings.....	50
Modbus Slave ID.....	50
Register Mapping .....	51
Error Returns .....	55
Chapter 8: PC/Laptop Access .....	57
Chapter 9: Datalogging.....	59
Chapter 10: Glossary .....	61
Elite – Pocket Reference.....	88
Elite Programming Sheets .....	89
Index.....	93

## Table of Figures

<i>Figure 1 Fiberglass NEMA 4x Enclosure.....</i>	4
<i>Figure 2 - Panel Enclosure Mounting Dimensions .....</i>	4
<i>Figure 4 - AC power wiring.....</i>	6
<i>Figure 5 - Wiring an external DC supply .....</i>	7
<i>Figure 6 - Recommended drill area for I/O connections.....</i>	8
<i>Figure 7 - Detail of I/O cards held with captive screws.....</i>	9
<i>Figure 8 - Preferred input wiring: two wires per channel. ....</i>	10
<i>Figure 9 - Daisy-chained, direct voltage input and contact to ground wiring. ....</i>	10
<i>Figure 10 - Open-collector connections.....</i>	11
<i>Figure 11 - Analog 4-20ma and Voltage connections for analog input cards.....</i>	12
<i>Figure 12 - Analog 4-20ma and Voltage connections for analog input cards with separate 24VDC connector .....</i>	13
<i>Figure 13 - Relay wiring .....</i>	14
<i>Figure 14 - Elite board connections .....</i>	15
<i>Figure 15 - Elite Front Panel .....</i>	21
<i>Figure 16 - Channel numbering .....</i>	30

---

## Copyright and Trademark Information

---

All Pages Copyright © 2013 Antx, inc. All Rights Reserved.

U.S. Government Users Restricted Rights. Use, duplication, or disclosure by the Government is subject to restrictions as set forth in applicable laws and regulations. Use of the materials by the Government constitutes acknowledgment of Antx' proprietary rights in them. This manual may contain other proprietary notices and copyright information that should be observed.

Information in this document is subject to change without notice. The software described in this document is furnished under a license agreement or nondisclosure agreement. The software may be used or copied only in accordance with the terms of those agreements. No part of this publication may be reproduced, stored in a retrieval system, or transmitted in any form or any means electronic or mechanical, including photocopying and recording for any purpose other than the purchaser's personal use without the written permission of Antx, inc.



# Chapter 1: Description

---

## ***What's Changed in this Version***

- If speaker volume is turned OFF, the local menu system runs faster as no messages are spoken
- Battery channel (02) goes into alarm if battery is disconnected
- Microphone level adjustment for recording messages
- Streamlined menu system when entering Phone Numbers
- Added setting analog output values via Modbus (Write Holding)
- Added ability to read packed digital inputs via Modbus and set a digital input to a specific bit
- Added ability to read an analog value (physical or Modbus) into another Modbus analog channel (i.e. copy analog to a channel)

---

## ***Overview***

DiaLog Elite is a state-of-the-art Remote Telemetry Unit (RTU), Controller and Alarm Notification system that provides:

- Continuous monitoring of up to 48 dry contact inputs, relay outputs or analog inputs in any combination, or up to 72 PLC registers.
- Complete programming locally through the keypad or a directly connected PC, remotely via phone or PC, or over the Internet.
- Event and data logging.
- Event-based control of local or remote relays based on changing digital and analog values.
- RTU functions including access to all current values and statuses using the Modbus RTU protocol or via a terminal emulation program like Hyperterminal
- Field-installable options.

---

## **Alarm capabilities**

By programming specific settings in the Elite, you define what conditions constitute an alarm and what action to perform when an alarm condition occurs. Actions supported by the Elite include:

- Calling phone and cell phones to deliver a user-specified alarm message.
- Calling pagers and alphanumeric pagers to provide alarm messages in digital and textual forms.
- Setting relays for local control or alarm annunciation.
- Send text messages.
- Setting local LEDs to alert personnel that channels are in alarm.

As people are informed of alarm conditions, they have the option to acknowledge the alarm, thus telling the Elite that the condition is understood and will be addressed.

As a remote monitoring system, the Elite allows you to call-in at any time and inquire about the status and current value of any or all conditions being monitored.

So, the Elite is your complete 24-hour a day, 7-day a week monitoring and notification system that allows you to turn your operations into unattended operations!

---

## **Control capabilities**

The DiaLog Elite is a complete stand-alone controller capable of turning relays on and off based on a number of conditions. These conditions can be grouped together so that when any of them are met, then the appropriate relay is activated or deactivated.

Relays can be located locally or remotely on other DiaLog Elite units.

Conditions on which relays can be activated or deactivated include:

- A digital input changing state
- A totalizer or time duration counter reaching a specified limit
- An analog input transitioning from the Normal state to the High Alarm state
- An analog input transitioning from the High Alarm state to the Normal state
- An analog input transitioning from the Normal state to the Low Alarm state
- An analog input transitioning from the Low Alarm state to the Normal state
- An analog input exceeding a Positive or Negative Rate of Change limit
- A command from a user from the front panel or via telephone
- A command from a SCADA system via the Modbus RTU interface

---

## **Expandable**

- Simple and affordable plug in cards for sensors, relays, or digital inputs
- Supports 8-48 physical input channels
- Relay expansion using 4-channel cards

---

## **Communications capabilities**

- Alarm notification via voice, pager, text messages
- Internet monitoring service
- Modbus Master to distributed sensors
- SCADA interface (Modbus Slave)
- Communicate between multiple Elite Controllers



# Chapter 2: Installation and Setup

---

## **Overview**

This chapter provides information on installing the DiaLog Elite and confirming its initial operation. Performing a proper installation ensures the correct operation of the DiaLog Elite for maximum life.

Please read the entire chapter before starting the installation.

---

## **What is the Installation Process?**

Installation consists of the following steps:

1. Unpacking the Equipment
2. Mounting the Equipment
3. Connecting the Main Power
4. Connecting the Input and Output Cards
5. Testing the System

Each step is described in detail in the remainder of this chapter.

---

## **Unpacking the Equipment**

The Elite is shipped with the following:

- The Elite in either a NEMA 4X plastic enclosure or metal enclosure,
- A set of I/O cards installed,
- A phone cord,
- An installed backup battery, and
- User Guide and Quick Reference Guide

## **Operating Environment**

The Elite should be installed in an environment that is not subject to shock or vibration. The operating temperature of the Elite is -40 to 150°F (-40 to 66°C).

If the Elite is going to be operating at temperatures below the operating temperature, we recommend that controlled heaters or heat strips be installed to keep the temperature adequately warm. Contact your local distributor, representative or the factory for additional information

---

## **Mounting the Equipment**

WARNING! 

A lock must be installed securing the cover to prevent non-service trained personnel from gaining access to the internal electrical circuitry of the Elite.

The Elite is available in a NEMA 4X enclosure or panel/flush mount enclosure.

### Fiberglass NEMA Enclosure

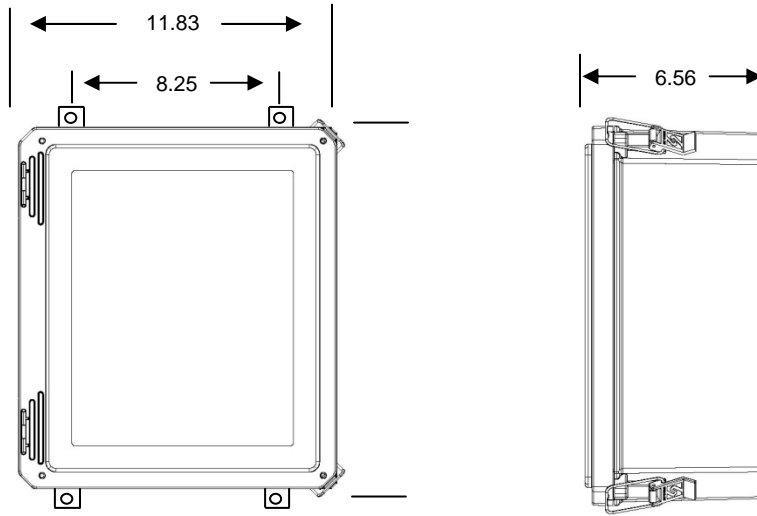

Figure 1 Fiberglass NEMA 4x Enclosure

### Panel Mount Enclosure

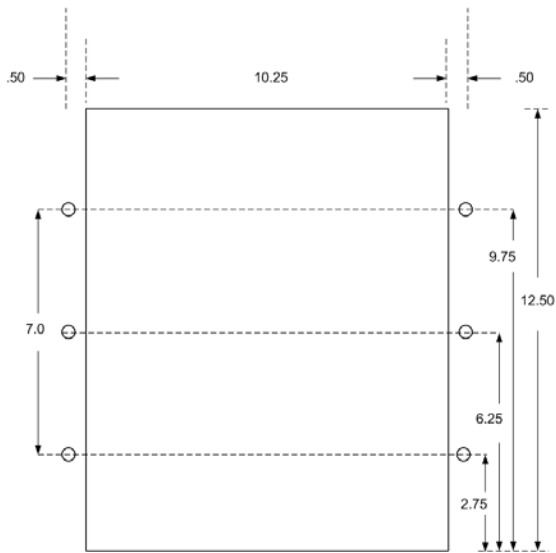
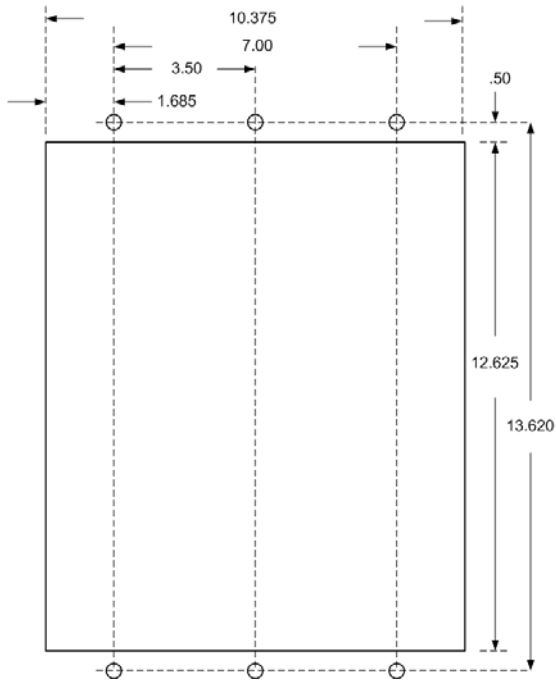

Figure 2 - Panel Enclosure Mounting Dimensions



*Figure 3 - Flush mount dimensions (hole cutout)*

*To mount the enclosure:*

1. Mount the unit using the six wall-mounting holes on the outside edge of the enclosure.
2. Use mounting hardware appropriate for the type of wall surface, and be sure the hardware and the surface are strong enough to handle the weight of the unit (25 lbs.).

---

## Main Power Connection

The Elite operates on 100 to 240 VAC, 50/60 Hz. Using 1.5A at 115VAC or 0.7A at 230VAC. There are no selections required by the user to select the input power. The main AC is connected to the Elite using the AC terminal block located inside the unit.

The terminal block is labeled L=Line (black), G=Ground (green or green/yellow), N=Neutral (white)

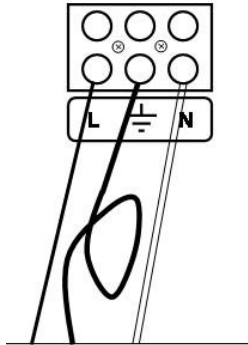

*Figure 4 - AC power wiring*

For the NEMA enclosure, you must drill an access hole to bring the wires into the unit. The access hole should be drilled on either the bottom or side of the enclosure.

---

WARNING! 

Be sure to look inside the unit prior to drilling so that you can be sure there is sufficient clearance for the hole and the fitting that you are using.

---

---

## AC Wire Size

The AC line wire should be 16 AWG or heavier wire.

---

## Proper Grounding

Elite must be earth-grounded by connecting a true earth ground to the ground terminal designated by the  symbol.

---

NOTE 

The Ground (green or green/yellow) wire should be made at least 2 inches longer than the other wires as a safety precaution in the event that the line cord is pulled out of the unit.

---

The Elite can be damaged by power surges and lightning through the telephone line and power supply. Although the Elite has built-in surge protection, we strongly recommend that additional protection be obtained for the unit and for any electronic equipment that is attached to your power supply and telephone lines. Power surge protection is especially important if you live in a lightning-prone area. Contact your sales representative, distributor or Antx for additional information on surge protection offerings.

---

NOTE 

Lightning damage is not covered under warranty.

---

CAUTION 

Failure to supply a good earth ground for the AC power causes the Elite's internal surge and lightning protection to be ineffective.

---

---

## Optional DC Power Connection

For applications where standard AC power is not available, the DiaLog Elite can be powered by an external DC power source. The system operates exactly the same with the exception of the following:

<b>DC power source</b>	<b>Elite operation</b>
15-24 VDC	Same as with AC
12-24 VDC	Same as with AC except the supplied backup battery is not charged by the Elite

To connect an external 15 to 24 VDC supply, disconnect the 3-wire harness from the processor board and then unscrew the three (3) wires from the plug and attach your supply.

Using this plug, wire in the external DC supply as shown below:

Ø	<b>1</b>	<b>Red (+)</b>
Ø	<b>2</b>	<b>Black (-)</b>
Ø	<b>3</b>	<b>Earth</b>

*Figure 5 - Wiring an external DC supply*

---

## Strain Relief

It is highly recommended that you install strain relief fittings for all AC or DC lines, phone cord and I/O wiring.

---

## Power Fuse

The AC to DC power supply has a small fuse near the AC input that may blow if the input AC current or voltage exceeds specifications.

If no lights on the Elite turn on when the power switch is put in the ON position, this fuse should be checked. Be sure to disconnect the Elite from the primary power source prior to checking this fuse.

If the fuse is blown, it can be replaced with a GFE 4A 250V.

---

## Phone Line Connection

The phone line connector is located on the left-hand side of the door after you swing it open.

---

WARNING! 

To ensure proper safety, the Earth Ground must be attached prior to connection of the phone line to the Elite by trained service personnel.

---

---

## Input and Output Cards

All connections to I/O cards utilize quick disconnect plugs. This allows all I/O wiring to be made to the connectors prior to plugging the connectors into the specific I/O cards.

When using the Elite mounted in a NEMA enclosure, it is necessary to drill holes into the enclosure. The holes should be drilled so that there is sufficient clearance from the sides and bottom of the enclosure for proper locking of a waterproof or conduit fitting.

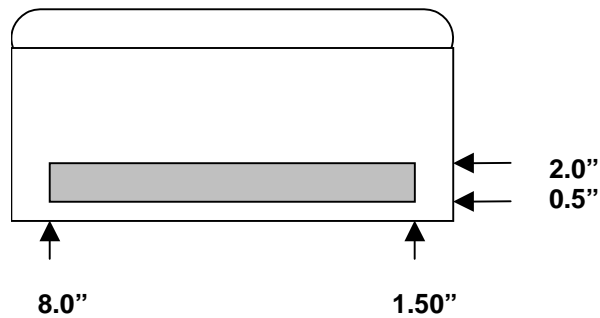

Figure 6 - Recommended drill area for I/O connections

When using the metal enclosure, access to the I/O cards is either through the conduit knock-outs on the sides of the enclosure or through the large removable access panel.

---

## Installing I/O cards

All Input and Output cards can be positioned in any of the six (6) I/O slots. For ease of wiring, you may want to leave blank spaces between cards if some of the slots are going to be empty.

There are three (3) types of Input and Output cards for the DiaLog Elite: Digital Inputs, Analog Inputs and Relay Outputs. Each of these cards can be placed in any of the I/O slots of the Elite. The slots are numbered from 10 through 60. When a card is positioned into a slot its channels are numbered by adding the channel number on the card to the slot number.

---

EXAMPLE 

For an 8-channel digital input card in Slot 30, the channels are numbered 31-38.

---

### *To install a card:*

1. Remove the I/O blank panel that covers the slot that you are going to use.
2. Slide the I/O card into the slot
3. Screw down the card into the slot using the two (2) black captive screws that are attached to the I/O card.
4. When the card is properly seated, you feel the card mating with the connector inside the enclosure.

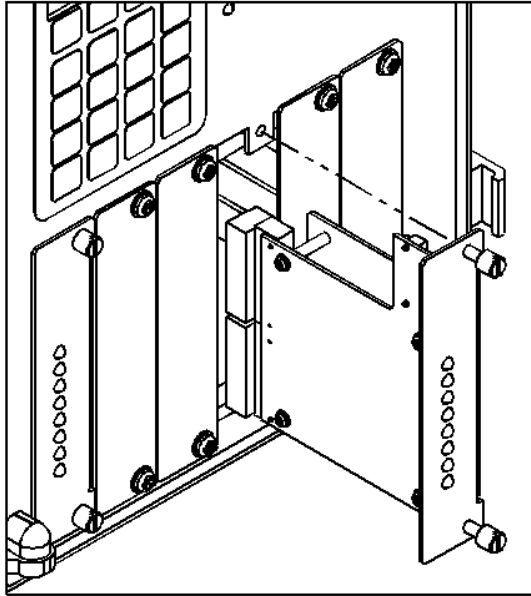

Figure 7 - Detail of I/O cards held with captive screws

---

## Digital Input Cards

The digital input boards are 8 channel modules. Each board is equipped with a quick disconnect plug that allows for easy connection of sensor wires. There are two (2) connections for each sensor, a (+V) and a (IN) as labeled on the board bracket.

Inputs to the board may be either:

- Dry contact, or
- 0-30VDC signals (0-6VDC is open, 6-30VDC is closed)

24 volts is used to complete the dry contact circuit to provide a means to break down the dielectric buildup on dirty switch contacts. The +V connection is 24VDC.

Each digital input is designed to monitor a Normally Open (NO) or Normally Closed (NC) relay or voltage input.

Terminals for all input channels are located on the opposite end of the card from the LEDs. There are separate quick disconnect connectors for each group of 4 inputs. The channel numbers are located on the metal housing next to each connector.

Notice that each connector has two (2) terminals, (IN) and (+V). If all of your inputs are originating from a location near each other, you can wire all of the (+V) signals together on the Elite connector and take a single (IN) signal to your sensors. See *Figure 9*.

If your inputs are widely distributed, we recommend that you use two (2) wires for each input. See *Figure 8*.

Medium gauge (18 to 22 WG) twisted pair wire such as Beldon #8205 or equivalent is acceptable. You may also use a multi-conductor cable if all your wiring is in the same panel.

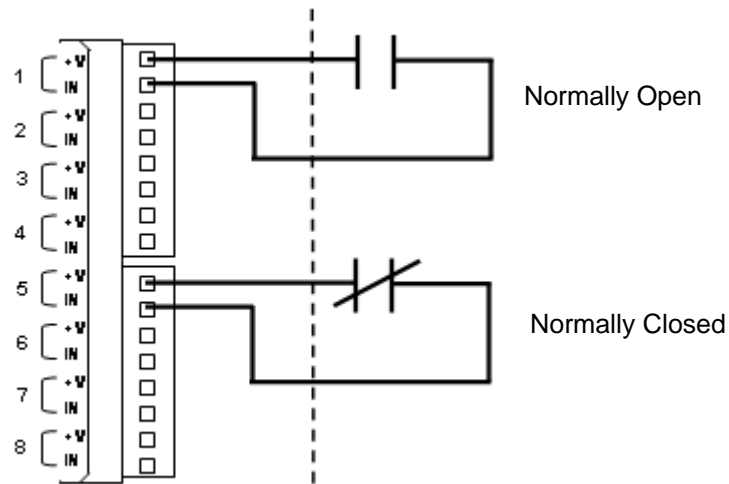

Figure 8 - Preferred input wiring: two wires per channel.

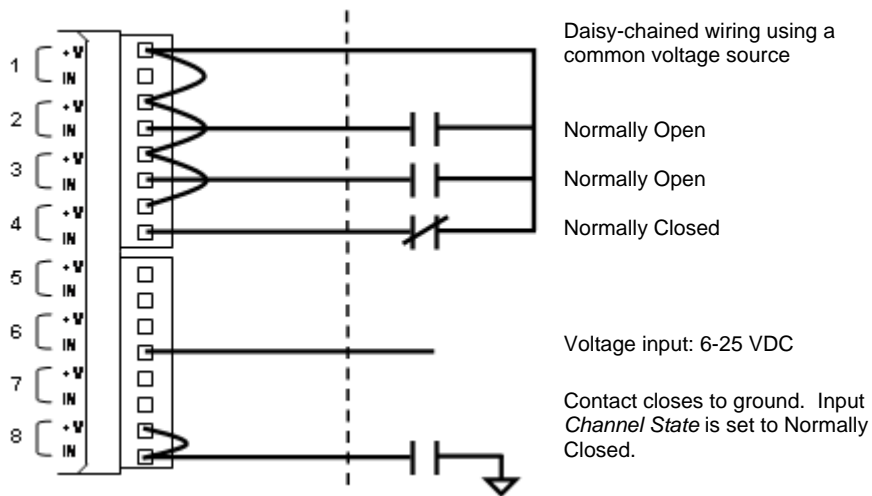

Figure 9 - Daisy-chained, direct voltage input and contact to ground wiring.

The 24VDC signal (+V) must be daisy-chained to all common points on the sensors that are being monitored to supply a power signal that can be sensed by the Elite.



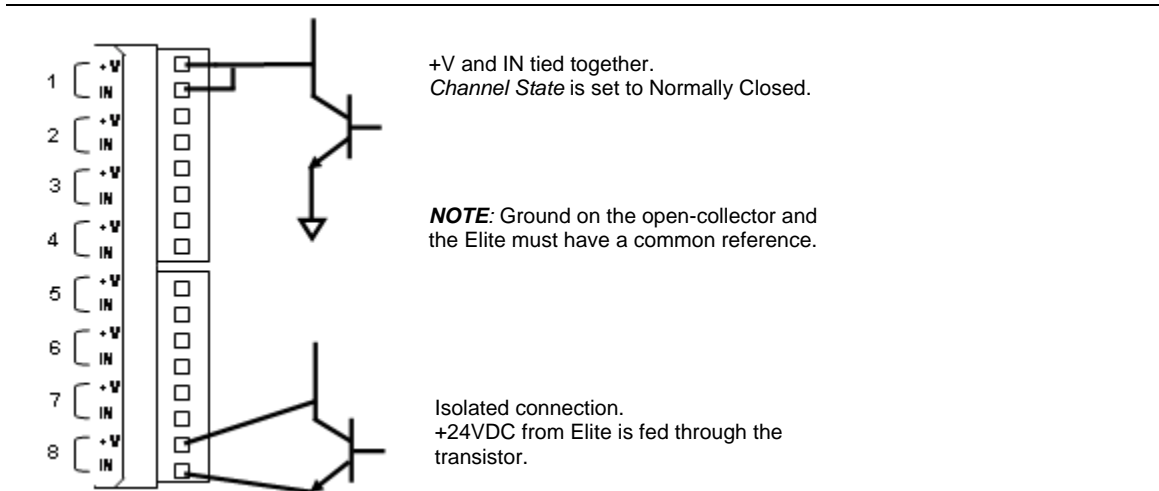

Figure 10 - Open-collector connections

## Analog Input Wiring

The analog input board has terminals for up to eight (8) channels to be connected. Each board is equipped with a quick disconnect plug that allows for easy connection of sensor wires.

<b>Unipolar Voltage</b>	<b>Current</b>
0 – 1 Volts	0 – 20ma
0 – 5 Volts	4-20ma
1 – 5 Volts	
0 – 10 Volts	

The current inputs (0 to 20ma and 4 to 20ma), require a supply of power to operate. You may power these inputs using the 24VDC supply that is on the top of the analog card or you may connect to an external power supply. The 24VDC supply can source up to 300ma on each analog input card, however the total available in an entire system is only 500ma.

Each channel of the analog input cards accept either current or voltage inputs, that are configurable through the programming. There are no switches or jumpers to set.

NOTE 

The (-) return on each Analog Input channel is connected to ground. If you are going to daisy-chain a current loop, then the Elite connection must be the last in the loop.

Each input channel is independent of any other input channel. A fault on one channel does not affect the conversion result on the other channels.

Antx recommends that you use medium-gauge wire (18 to 22 AWG) twisted pair.

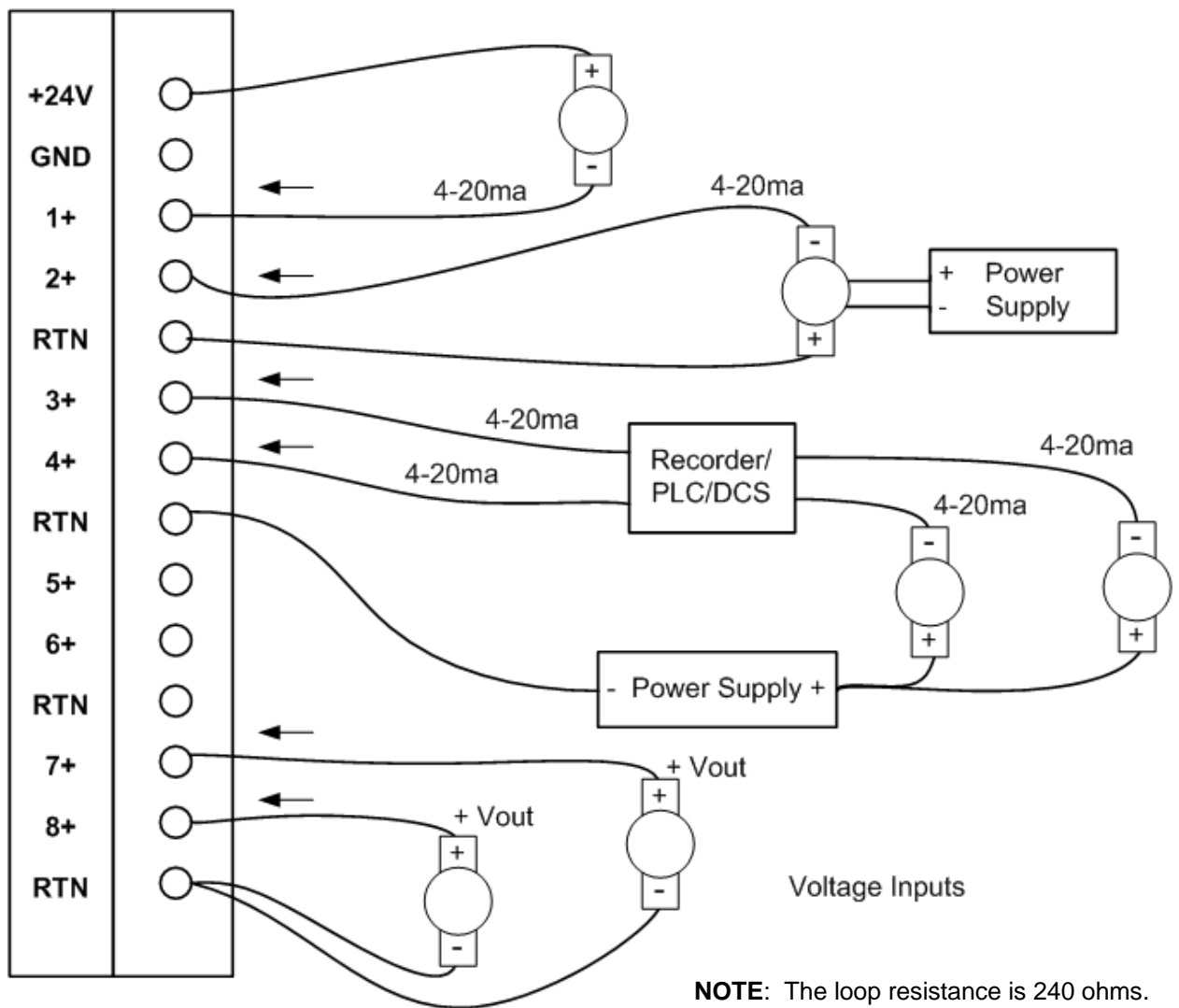

**NOTE:** The loop resistance is 240 ohms. The maximum current from the 24VDC supply on the analog card is 250ma. The entire Elite can supply 300ma.

Figure 11 – Analog 4-20ma and Voltage connections for analog input cards

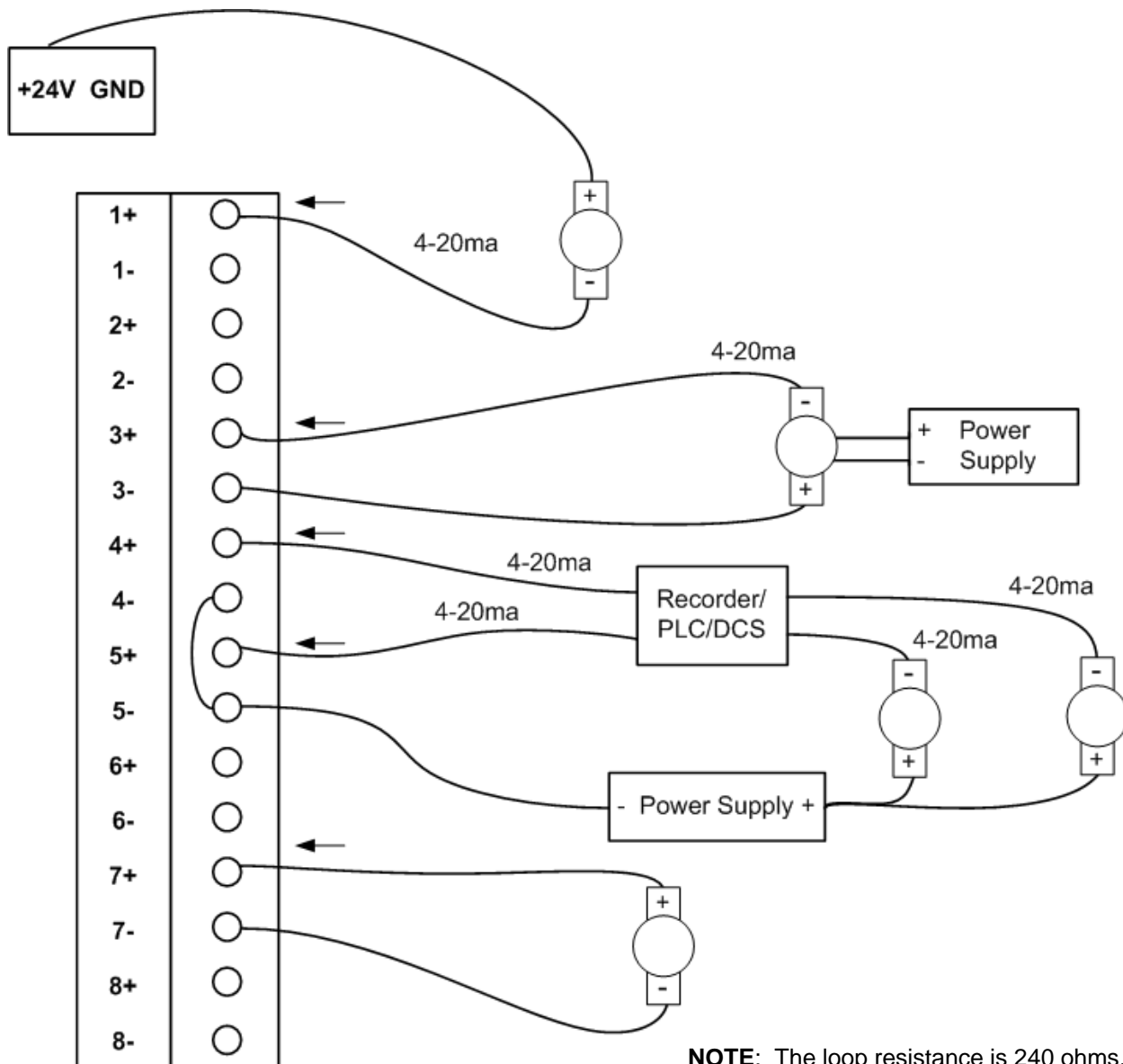

**NOTE:** The loop resistance is 240 ohms. The maximum current from the 24VDC supply on the analog card is 250ma. The entire Elite can supply 300ma.

Figure 12 - Analog 4-20ma and Voltage connections for analog input cards with separate 24VDC connector

---

## Relay Wiring

Each relay output board has terminal connections for four (4) relays. The Elite can be configured for a maximum of 24 relays, each independently controlled either directly or under alarm conditions.

Each board is equipped with two quick-disconnect plugs that allow for easy connection of sensor wires. There are three (3) connections for each relay: *Normally Open* (NO), *Common* (C) and *Normally Closed* (NC) as labeled on the board bracket.

Relay outputs are typically used to control other equipment, lights, horns or visual alarm indicators.

Each relay output board has four (4) Single-Pole Double-Throw (SPDT) relays. The switching capability of each relay is:

- 8 Amps at 125 VAC    6 Amps at 277 VAC    5 Amps at 30 VDC

The following diagram shows proper wiring for a relay.

---

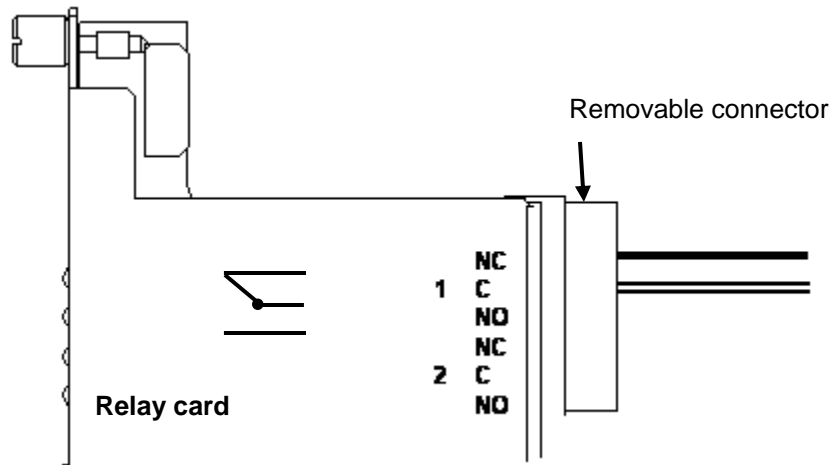

Figure 13 - Relay wiring

---

## Turning on the Elite

The power switch for the DiaLog Elite is located on the processor board mounted on the back of the front panel. To turn the power on, open the front panel and move the slide switch (SW1) to the on position.

The Elite powers up under either primary power +VS (24VDC) or battery backup VBAT (12VDC). When the power is turned on, the Elite runs power up diagnostics to confirm operation of all standard and optional components.

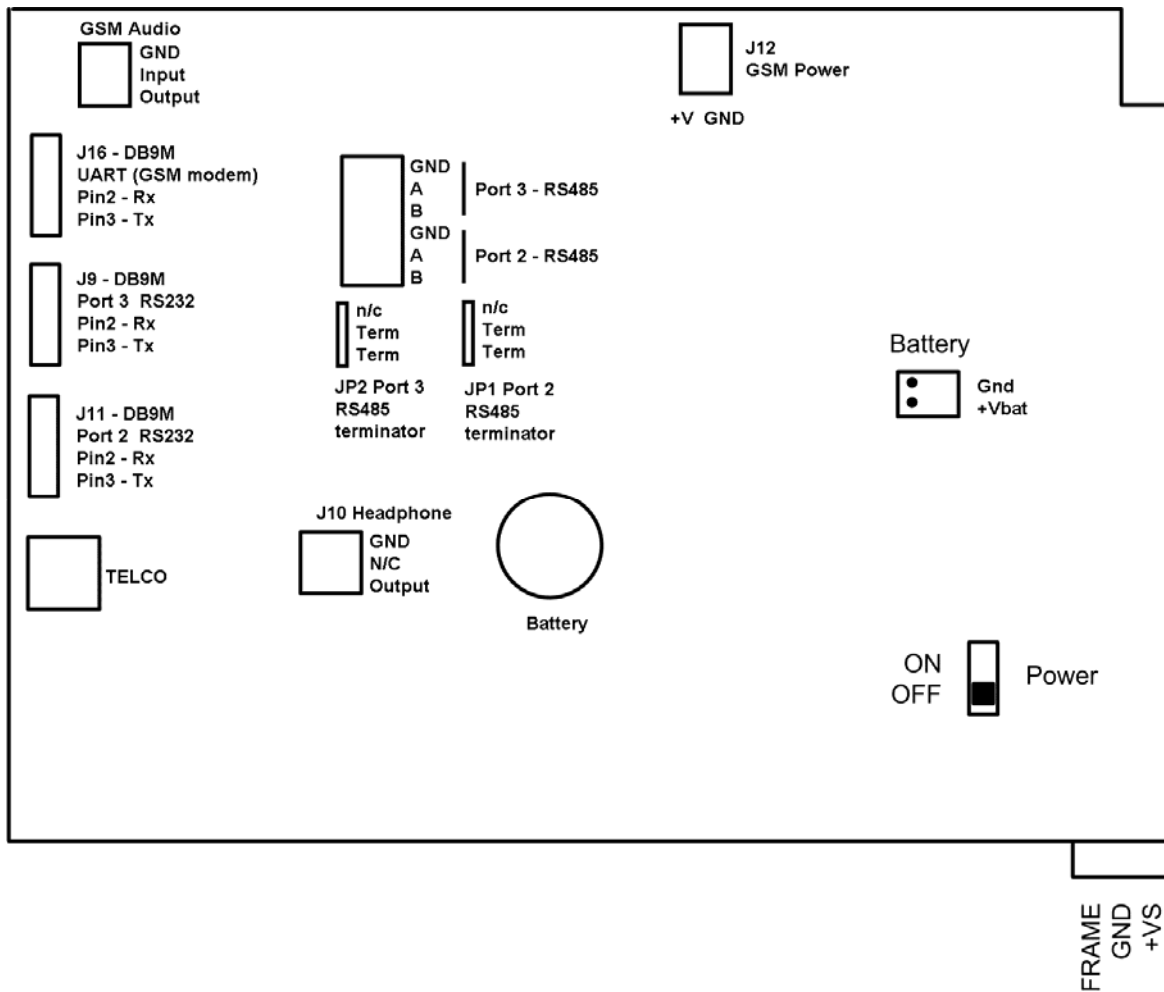

Figure 14 - Elite board connections

---

## Verifying Battery Backup Connection

The Elite has either a 12V 7AH or 5.5AH sealed lead-acid rechargeable battery. This provides approximately 24 hours of backup time with the unit fully configured. Actual backup time depends upon the number of input/output cards installed in the unit, the number of sensors being powered from the unit, temperature, battery age, and dialing activity. The battery comes pre-wired with the red wire attached to the +VBAT terminal and the black wire attached to the -VBAT terminal. (replacement battery part number is EBAT001 for 7AH or EBAT002 for 5.5AH)

The Elite automatically charges the battery whenever the power switch is turned on. The unit also includes special circuitry to prevent the battery from being damaged in the event of an extended power outage. When the battery runs down to 9V, the unit automatically disconnects it, preventing deep-discharge damage. The battery remains disconnected until it charges back up to 12.3 volts. The battery provides at least two (2) years of service before needing replacement.

When the Elite is being powered by the backup battery, the LEDs and display are put into a 'dimmed' mode to conserve power.

The main motherboard also includes a 3V lithium battery to maintain the real-time clock and portions of the SRAM memory. Each battery provides ten (10) years of use. If the date and time in the Elite are not retained when power is turned off then on, the battery needs replacing. (replacement battery part is EBAT010)

Verification of the backup battery being properly connected is accomplished by requesting the status of the System Channel for the battery, channel 02.

---

WARNING! 

Caution

Risk of explosion if battery is replaced with incorrect type.  
Dispose of used batteries according to the instructions.

---

## Chapter 3 - Quick Start

This chapter provides step-by-step instructions on how to:

- Program a list of phone numbers
- Program an alarm message (optional)
- Program for tracking pump run times (optional)
- Setting up an Analog Input (optional)
- Pocket Reference card with easy commands for common functions
- Test the system

In addition, this chapter lists the default values that come shipped with the DiaLog Elite.

---

### **Default Values**

The DiaLog Elite is shipped with factory-configured default settings that make it usable when it is installed.

<b>Parameter</b>	<b>Default Setting</b>
<b>Digital Inputs</b>	
Channel Name	DIN xx
Channel Message	Digital input channel xx
Channel State	Set to normally open
Channel Mode	Set to Call on Alarm
Telephone List	1
Alarm Delay	3 seconds
Relay	None
<b>Analog Inputs</b>	
Channel Name	AIN xx
Channel Message	Analog input channel xx
Input type	4-20ma
Decimal position	1
Engineering units	None
Zero scale	0
Full Scale	100
Channel Mode	Set to Call on Alarm
Telephone List	1
Alarm Delay	3 seconds
Relay	None
<b>Relay Outputs</b>	
Channel Name	RLY xx
Channel Message	Relay channel xx
Channel Mode	Status Only
Pulse Duration	none

---

## Quick Programming Steps

While there are a large number of options available in the Elite, it is very easy to get the system up and operating if you first decide on what conditions are being monitored, the messages you want, the phone numbers for alarm notification and what relays, if any, are going to be controlled.

---

### Step 1 – Configure the System Identification

Actions	Keystrokes
<ul style="list-style-type: none"><li>- Enter Program Mode</li><li>- Record system identification voice message</li><li>- Enter system identification number</li><li>- Enter system name using the keypad (Page 25)</li><li>- Entry complete</li></ul>	HOME 1 3 0 1 <your message> # <phone number of Elite> # <system alphanumeric id> # HOME

---

### Step 2 – Configure the Phone numbers for list 1

Actions	Keystrokes
<ul style="list-style-type: none"><li>- Enter Program Mode</li><li>- Enter phone number for list 1 position 1</li><li>- Back to top of menu</li><li>- Enter phone number for list 1 position 2</li><li>- Back to top of menu</li><li>- Enter phone number for list 1 position 3</li><li>- Back to top of menu</li><li>- Repeat for next position or go to next step</li></ul>	HOME 1 4 0 01 01 <phone number> # HOME 4 0 01 02 <phone number> # HOME 4 0 01 03 <phone number> # HOME 4 0 01 xx <phone number> #

---

### Step 3 – Setup Digital Inputs (skip if not using digital inputs)

Actions	Keystrokes
<ul style="list-style-type: none"><li>- Enter Program Mode</li><li>- If channel is NO skip this, otherwise change to NC</li><li>- Enter message for channel, 1 to record a message</li><li>- Enter system name using the keypad (Page 25)</li><li>- Back to top of menu</li></ul>	HOME 1 9 <chan #> 0 1 1 1 <your message> # <channel name> # HOME

---

### Step 4 – Setup Analog Inputs (skip if not using analog inputs)

Actions	Keystrokes
---------	------------



<ul style="list-style-type: none"> <li>- Go to Program mode</li> <li>- Setup channel parameters</li> <li>- 1 = 0-5V, 3 = 0-10V, 5 =4-20ma</li> <li>- Number of digits to the right of the decimal</li> <li>- See Engineering Units page 71</li> <li>- Scale Input</li> <li>- Value at 0V or 4ma</li> <li>- Value at 5V, 10V or 20ma</li> <li>- Channel message</li> <li>- Enter channel name using keypad</li> <li>- See Alarm Mode 0 through Alarm Mode 4 page 63</li> <li>- Enter low limit in engineering units</li> <li>- Enter high limit in engineering units</li> <li>- Entry complete</li> </ul>	HOME 1 9 <chan #> 0 <type> <decimal position> <engineering units> 0 <zero scale> # <full scale> # 1 <your message> # <channel name> # 2 <channel mode> <low limit> # <high limit> # HOME
--	---

---

### Step 5 – Compute motor run times (optional)

Actions	Keystrokes
<ul style="list-style-type: none"> <li>- Go to Program mode</li> <li>- Channel Configuration</li> <li>- Enter digital input channel number</li> <li>- Set Channel Mode to Call on Limit</li> <li>- Entry complete</li> </ul>	HOME 1 9 xx 2 3 HOME

---

### Step 7 – Save Programming

Press HOME 2 to save programming into non-volatile memory.



---

## Testing the system

This test assumes that:

- Elite has primary power,
- Elite is connected to the phone system,
- Elite has a digital input wired into Channel V+ and IN on the digital input card, and
- The LED for channel 11 is solid green, indicating that it is enabled.

*To make sure DiaLog is working:*

1. Force Channel 11 into alarm by closing the contact or relay that is connected to channel 11.
2. Verify that the system is in RUN mode (Run indicator is solid green). If not, press   to put the Elite into RUN mode.
3. Check for the following.
  - The Channel 11 LED starts blinking red after the 3 seconds (the default Alarm Delay).
  - The red Phone Off Hook indicator is lit to show that the system is attempting to dial the first telephone number on Telephone List 1.

*To acknowledge the alarm at the operator panel:*

1. Press . (NOTE: If the Elite is already making a call, you must press HOME to cancel the call)
2. The Channel 11 LED indicator goes from blinking (unacknowledged alarm) to steady ON (alarm acknowledged but not corrected).
3. Complete the test by correcting the alarm at Channel 11 by opening the contact or relay.
4. The Channel 11 LED indicator should return to the solid green state.

# Chapter 4: Operation

---

## Overview

The Elite provides real-time display and alarm notification of monitored conditions. Monitored conditions are connected to the Elite as current or voltage signals to 8-channel analog input cards and dry or wet contacts into the digital inputs. There can be up to six 8-channel cards in a system for 48 physical points total.

Each input has several alarm limits associated with it, each of which can control a separate alarm relay. The Elite can support 4-channel relay cards that can be connected to lights, horns, blowers, motors or other equipment.

The display shows the current status of alarms, input readings and all programming prompts and settings. Programming is performed by pressing keys on the keypad and listening to and viewing the programming prompts. LEDs are provided for each sensor and relay and indicate the current state of each.

The DiaLog Elite can be programmed in four ways:

- from the keypad,
- over a telephone,
- from a locally connected PC Chapter 8: PC/Laptop Access., or
- using the Web-based software over the Internet.

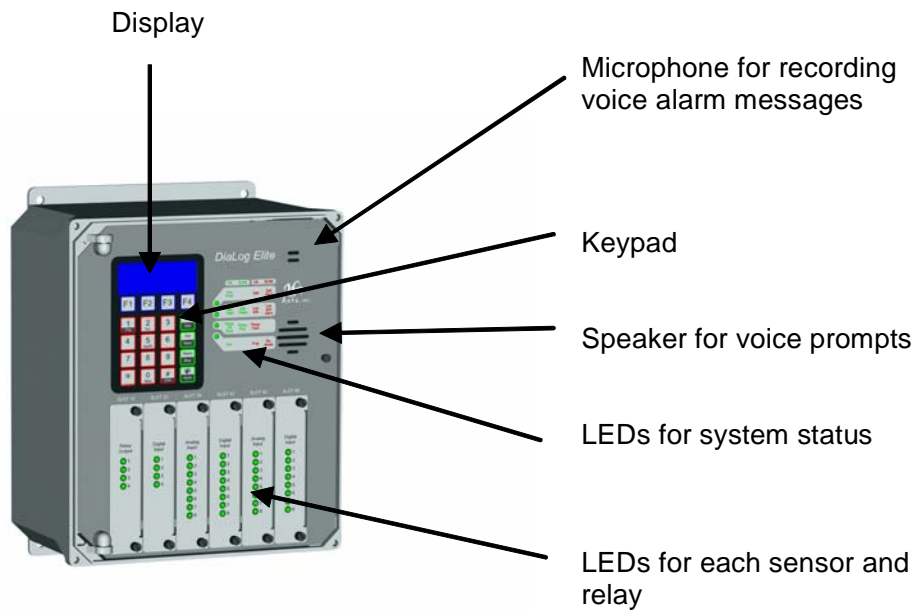

Figure 15 - Elite Front Panel

---

## How to use the Keypad

### The red keys

The keypad allows functions to be performed locally by pressing individual keys or sequences of keys. The keypad is divided into several sections, each with its own color.

The RED keys are the typical phone-pad keys and are used to enter numbers to navigate through menus, enter phone numbers, and select various options when programming. Several of the RED keys are split, where the top of the key has a number or symbol and the bottom of the key provides a function.

EXAMPLE ➤



The 5 key has SpkrPh at the bottom, providing access to the *Speaker Phone* function.

### The green keys

The GREEN keys provide quick single-key operation for specific functions. Each of the GREEN keys is split:

- The top of key indicates the operation performed when the system is in RUN mode, and
- The bottom of the key indicates what operation is performed when the system is in PROGramming mode.

EXAMPLE ➤



The Disarm/Bksp key allows you to disarm the system when in RUN mode and erase the previous key entry when in PROGramming mode.

### The blue keys

The BLUE keys, or Quick Access keys. The bottom row of the display has text above each key that defines the function that is performed when that F-key is pressed.

## Programming Keys when Calling in

To enter *PRO*Gramming mode from a remote Touch-Tone telephone:

1. Dial Elite's number.
2. The Elite answers after the number of rings specified by Ring Count.
3. Elite says, "Press any key to continue." You have 5 seconds to press any key on the phone keypad.
4. After the System Status message and the three beeps, press **#**, then **1**.
5. Enter the access code, if required.  
The Elite says, "System ready. Enter selection".

The front panel keypad includes five shortcut keys to speed up programming:

































You can perform the same functions at a remote telephone using combinations of the standard 12 keys. When you use **\*** (Star) with another key, press **\*** then press the numeric key.

	<b>Over the Phone</b>	<b>Function</b>
	<b>*</b> or <b>8</b> or <b>9</b>	In RUN mode: acknowledges channels in alarm according to the Call in Acknowledge setting.
	<b>*</b> <b>2</b>	Cancel the entry and restore the factory setting.
	<b>*</b> <b>6</b>	Cancel the entry being made, retain the present setting and return to the top of the menu for the "System ready" prompt.
	<b>#</b>	Enters the value or ends the current input.
	<b>*</b> <b>4</b>	In RUN mode, prevents the DiaLog from calling out.
		When in Speakerphone mode: Increase the microphone sensitivity level.
		When in Speakerphone mode: Decrease the microphone sensitivity level.
		When in Speakerphone mode: Increase the speaker volume.
		When in Speakerphone mode: Decrease the speaker volume.

## Local Key summary

Below is a listing of each key in RUN mode and in PROGramming mode.

Key	When in RUN mode	When in PROGramming mode
	Puts the Elite into the PROGramming mode	
		At the top level of the menu, puts the Elite into RUN mode. When not at the top of the menu, functions like a 
		 System Status
	Manual phone check	 Phone (optional)
	Enables the speaker phone	
		 Schedules (optional)
	Enables activation/de-activation of specified relays	 Relay Lists
		 Options Setup
		 Channel Configuration
	Speaks and displays status of specified channels.	
		
		Completes entry or backs up the menu.
	Acknowledges all unacknowledged alarms	Clears any entry made for the specified function
	Enables call-out of alarms	Resets the entry made to the factory default value
	Disables call-out of alarms	Erases the previous key entry
		Puts the Elite at the top of the selection menu
   	Quick Access key – specific function is displayed above the key on the display.	

RED keys

GREEN keys

BLUE keys

---

## How to Enter Text for Names

The Elite allows the user to enter names for the Site (Unit) and for each channel. Entering names is very similar to entering names on most cell-phones that are used today.

On the bottom of each key, there are letters and numbers. To select a specific letter or number, press that key the designated number of times. For example, to enter the letter 'L', press the 5 key 3 times.

---

NOTE 

The Elite automatically capitalizes the first letter of each word. All subsequent letters are lower case.

---

Key to Press	Number of times to press the key				
	1	2	3	4	5
1	space	1			+
2	A	B	C	2	.
3	D	E	F	3	,
4	G	H	I	4	-
5	J	K	L	5	*
6	M	N	O	6	#
7	P	R	S	7	/
8	T	U	V	8	Space
9	W	X	Y	9	Space
0	Q	Z	0	0	@
*	Erases previous letter				

---

## ***RUN Mode Operations***

The Elite monitors all inputs and evaluates all alarm conditions when in the RUN MODE. While in this mode, the Elite automatically displays all enabled input channels. Enabled channels are those that have a green LED shown on the analog or digital input card or a Modbus Master channel.

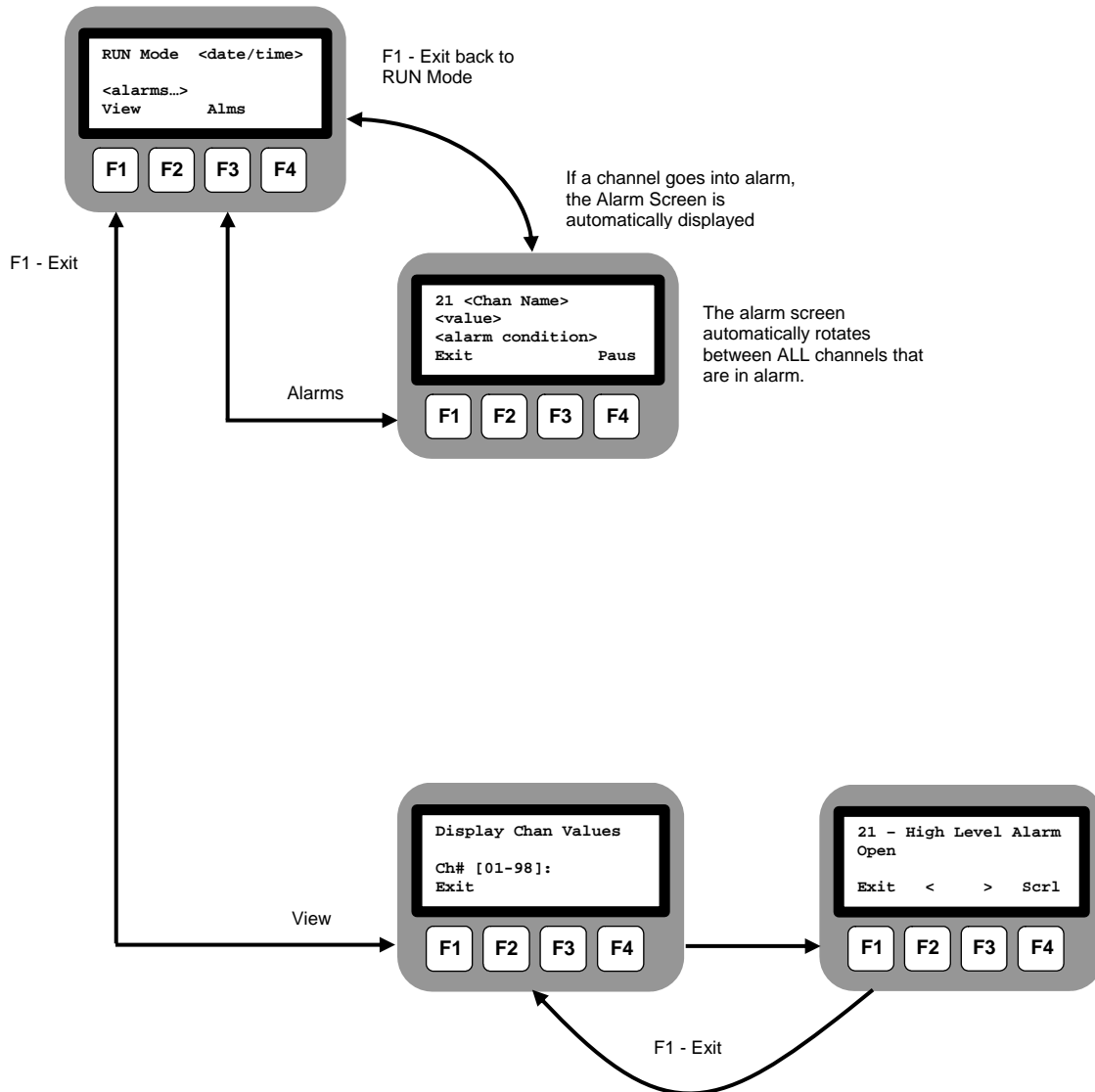

---

## ***Viewing the Display***

When in RUN MODE the Elite shows the following display:



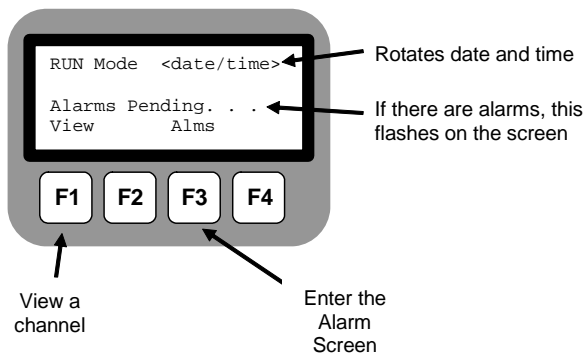

## Automatic Alarm Screen

When any channel goes into alarm, the display automatically changes to show the current conditions of those particular channels.

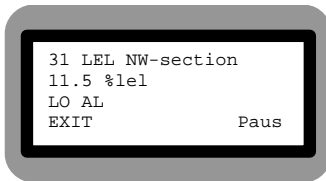

If any channel goes into alarm, the Alarm Screen is automatically displayed. All channels that are in alarm are automatically shown one at a time.

For example, Channel 31 is monitoring an LEL sensor in the NW section, which is at 11.5 %lel, has exceeded the Low (LO) limit and is in alarm (AL).

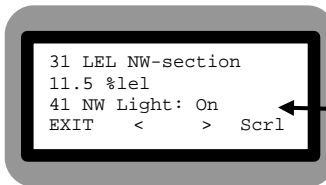

Pressing the Paus (**F4**) key pauses the screen on a particular channel of interest.

Displays all relays being controlled and the relay states.

Press the < or > to move the previous or next channel.

Press the Scrl (**F4**) key to return to the scrolling display of all channels in alarm.

Valid Alarm Conditions	
AK	Alarm is acknowledged and still in alarm
AL	Channel is in alarm and un-acknowledged
CM	Communications alarm – this channel is read via Modbus RTU and the communication is failing.
HI	In High alarm condition
LO	In Low alarm condition

## How alarms are presented via LEDs

When a channel goes from the normal state to the alarm state, one or more of several notification methods are activated. Alarms can be presented in any of the following ways:

- A local LED changes color from Green to Green Blinking, then to Amber or Red Blinking
- Local activation of a specified relay
- Remote activation of a specified relay

- Call out to a phone, pager or alphanumeric pager

<b>Channel LEDs</b>	
<b><i>Color</i></b>	<b><i>Definition</i></b>
Constant Green	Channel is normal
Blinking Green	Channel is in alarm condition but has not met the Alarm Delay period
Constant Yellow	Channel has exceeded the Low Limit and is acknowledged (Elite controller only)
Blinking Yellow	Channel has exceeded the Low Limit and is NOT acknowledged (Elite controller only)
Blinking Red	Channel has exceeded the High or Low Limit or for a digital input is in the Non-Normal state and is NOT acknowledged
Constant Red	Channel has exceeded the High or Low Limit or for a digital input is in the Non-Normal state and is acknowledged

## System Channels

There are a few channels that are always present in each system. These are referred to as System Channels. They behave just like other Analog and Digital channels, and can be modified as desired.

Channel Number	Channel Name	Function	Default Settings
01	Primary Power	Monitors the primary 15VDC power supplied to the main processor board.	<ul style="list-style-type: none"> <li>- Goes into alarm when primary power is lost for 30 seconds.</li> <li>- Limits are 14.0 and 16.0</li> <li>- No Relay List is set</li> </ul>
02	Battery Power	Monitors the battery backup power.	<ul style="list-style-type: none"> <li>- Goes into alarm when low battery voltage is detected for 120 seconds.</li> <li>- Limits are 10.0 and 14.0</li> <li>- No Relay List is set</li> </ul>
03	Phone	Monitors dial-tone availability every 2 hours if the phone Channel Mode is not disabled.	<ul style="list-style-type: none"> <li>- No Relay List is set</li> </ul>
04	Temperature	Monitors the on-board temperature.	<ul style="list-style-type: none"> <li>- Status Only (no alarming)</li> <li>- Limits are 5.0 and 70.0 C</li> <li>- No Relay List is set</li> </ul>
06	Communication	<p>Monitors Modbus RTU Master communications to Slave devices. If communication is lost for a period of time, then this channel and other Modbus channels go into alarm.</p> <p><b>NOTE:</b> Typical causes for going into alarm are: wrong baud rate, wrong Modbus ID or register number, disconnected cable.</p>	<ul style="list-style-type: none"> <li>- Alarm Delay is 60 seconds</li> <li>- No Relay List is set</li> </ul>
07	System Fault	Monitors each enabled analog (current) channel to confirm that there is not an open loop condition.	<ul style="list-style-type: none"> <li>- Alarm Delay is 10 seconds</li> <li>- No Relay List is set</li> <li>- Limit is set to .5ma</li> </ul>

## Physical Channel Numbering

The channel numbering and function of each LED is shown below.

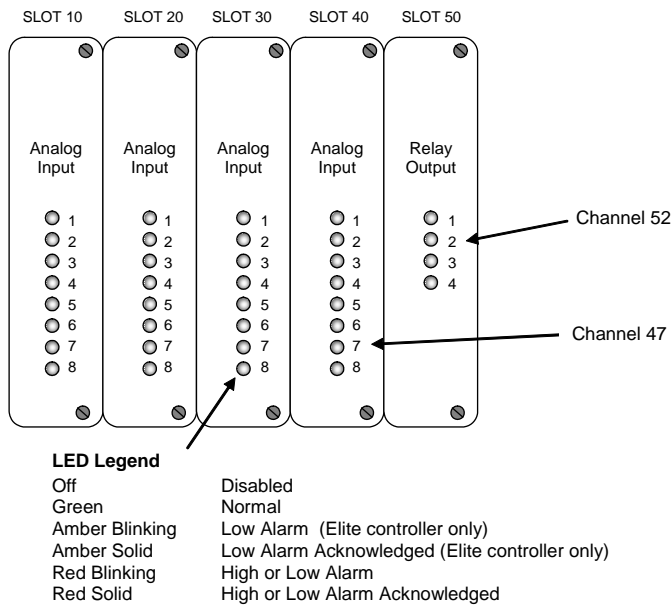

Figure 16 - Channel numbering

## Modbus Channel Numbering

When the Elite is a Modbus Master, channels are 'logical' instead of physical. Modbus channels are still Slot oriented and numbered like physical channels.

To read or write in a value from/to a Modbus Slave device:

- configure a Slot in the Elite to be a Modbus slot
- configure a channel, as listed below, to read or write coils, holding, etc.

SLOT	Modbus Channel numbers
10	11-18
20	21-28
30	31-38
40	41-48
50	51-58
60	61-68
70	71-78
80	81-88
90	91-98

## RUN Mode screens

Users can view Data and Alarms through the following process:

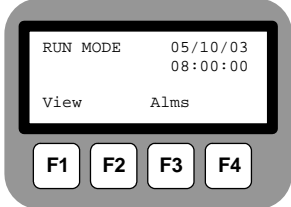
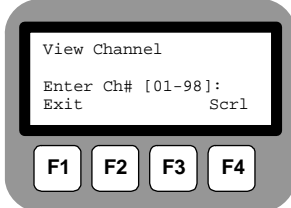
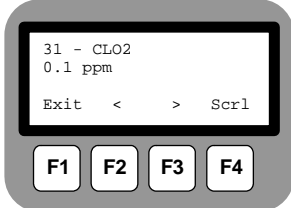
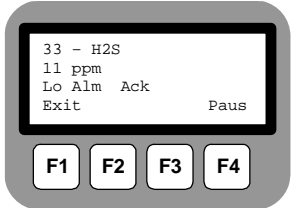
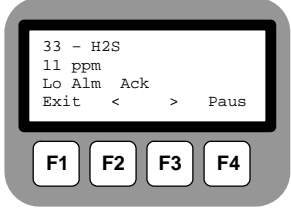
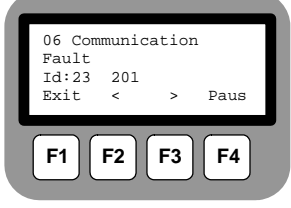
User Input	Display Shows
<p><b>RUN MODE</b> display</p> <p>F1 to go to the <b>View Channel</b> display F3 to go to the <b>Channels in Alarm</b> display</p>	
<p><b>View Channel</b> display</p> <p>F1 to return to the <b>RUN MODE</b> display F4 to go to the <b>Scrolling channel</b> display</p> <p>Enter a channel number to go to the <b>View Data</b> display.</p>	
<p><b>View Data</b></p> <p>F1 to go to <b>Exit</b> this display and return to <b>View Channel</b> display F2 to move to the previous channel F3 to move to the next channel F4 to go to the <b>Scrolling Channel</b> display</p>	
<p><b>Scrolling Channel</b> display</p> <p>F1 to exit to the <b>View Channel</b> display F4 to go to the <b>View Data</b> display</p> <p>Automatically scrolls through all enabled channels.</p>	
<p><b>Channels in Alarm</b> display</p> <p>F1 to exit to the <b>RUN MODE</b> display F2 to display the <b>previous channel</b> in alarm F3 to display the <b>next channel</b> in alarm F4 to <b>pause</b> on this specific channel</p>	
<p>If the Elite is a Modbus Master and there is a communications error with reading a channel, then channel 06 (Communications channel) goes into alarm if the Channel Mode is Call on Alarm and the Alarm Delay has expired. The "Id:" field displays the Modbus IDs that cannot be read. (for example, channels using IDs 23 and 201)</p>	<p>OR</p>  <p>OR</p>

---

## User Input

## Display Shows

---

An alarm on channel 03, the Phone channel, indicates that when the Elite checked for a dial-tone it did not find a dial-tone.  
**NOTE:** Phone LED will be on red solid.

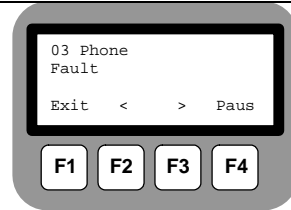

OR

If no channels are in alarm.

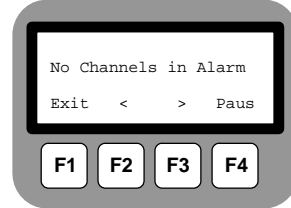

---

## Activate/Test Relays

Press F1 to exit to the **RUN MODE** display.  
Keypad 7 to enter **RELAY** and **Output** functions  
Keypad 1 to Activate a single Relay  
Keypad 2 to Activate a Relay List  
Keypad 3 to set a Modbus Holding Register

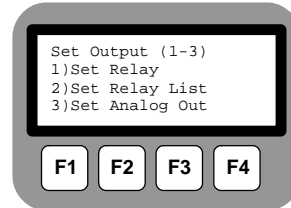

---

## Acknowledging Alarms

Alarms can only be acknowledged from RUN mode. They can be acknowledged in three ways:

- Locally using the keypad,
- Remotely when an alarm message call-out is received,
- If an Ack input channel has been designated, or
- Remotely by calling into the Elite.

In all cases, when an alarm is acknowledged no further call-outs are made to inform people or systems that alarm conditions exist.

---

### From the Front Panel

At the front panel, press the  key to acknowledge a channel that is in alarm. All channels that are in alarm are acknowledged at the same time. The **Red** blinking LED channel indicator changes to **Red** steady On, indicating that the specific channel is still in alarm, but has been acknowledged.

**NOTE:** If the Elite is in the process of making a phone call, press the HOME key to abort the call first.

---

### Remotely when Called

When you receive an alarm notification call at a remote telephone, Elite delivers the message, “Please acknowledge”, and waits 5 seconds for you to enter , , or  (Acknowledge).



If Elite has finished speaking to acknowledge the call. If Elite does not receive an Acknowledge signal, it repeats, “Please acknowledge” and waits another 5 seconds. It repeats this message sequence and then hangs up and waits for a return call.

---

If Elite receives an Acknowledge signal, it says, “Alarms acknowledged”, beeps three times and waits 5 seconds for you to press ENTER to begin programming. Your , , or  signal acknowledges only the alarm message(s) you received. On the other hand, if Call In Acknowledge is enabled, a return call during the Between Calls Delay acknowledges alarms as specified by the Call in Acknowledge settings.

---

### Acknowledge input channel

If an Acknowledge Input Channel has been specified, then alarms are acknowledged when this input goes to the non-normal condition.

---

### Remotely when Calling In

Depending on the setting of Call in Acknowledge, the Elite allows you to acknowledge no alarms, all alarms or specific alarms.

---

## How to Prevent the DiaLog Elite from Calling Out (Disarming)

When personnel are performing maintenance on equipment being monitored by the Elite, it is desired to prevent the Elite from calling out alarms or activating relays.

This is accomplished by Disarming the Elite by pressing the  key on the local keypad.

When the Elite is in RUN mode, pressing \*4 on your phone handset toggles the **ARM/DISARM** setting. The Elite responds by saying either “System is disarmed” or “System is armed”.

The Elite continues to process alarms, illuminate LEDs, write to the Event Log and answer call-ins, but it does not initiate any call outs. Alarms are not called out, and Status Notification calls are not made.

Relays can be activated when the Elite is Disarmed from the following methods:

- Activate Relay Command – either locally or remotely
- Activation from a Modbus command from another DiaLog Elite or from a SCADA package.

---

NOTE 

The Disarm to Arm Delay can be used to specify an amount of time that the Elite stays Disarmed until it is automatically returned to Armed mode.

---



# Chapter 5: PROGramming Mode from the Keypad

## Overview

PROGramming mode allows the user to:

- Change system wide settings
  - Name of the unit
  - Date/Time
  - PROGramming Access Code
- Add/Change phone numbers and settings
- Add/Change schedules
- Change the settings for an input
  - Low and High limits
  - Scaling
  - Relays to control
  - Name of the channel
  - Engineering units

PROGRAM MODE is entered by pressing the  key while on the RUN mode display.

RUN mode is re-entered by pressing the  key from the PROGRAM MODE display.

NOTE 

If an Access Code has been entered, the user is prompted to enter it before PROGramming mode is entered.

## Display – Selecting a menu item

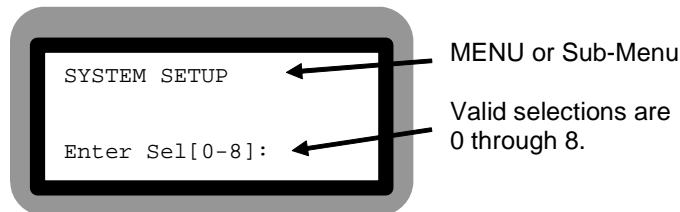

## Display – Changing a setting

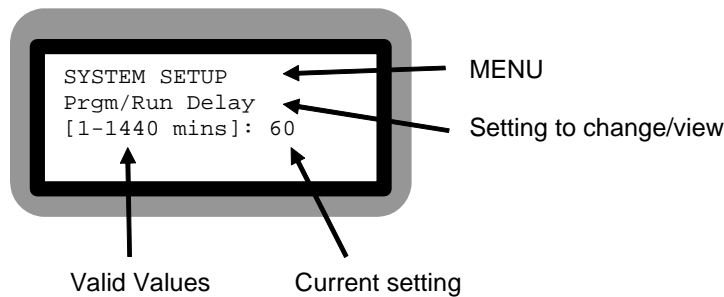
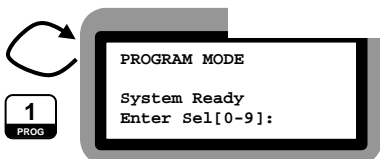



Figure 17 - PROGramming mode display options



## System Wide Settings

These settings affect the overall operation of the system. These settings are typically adjusted during the initial installation, but can be modified at any time.

NOTE 

Press the # key to:

- move to the next program setting or
- to move up a level in the menu or
- to accept your entry

### PROGRAMMING MODE display

**3**

to enter System Setup

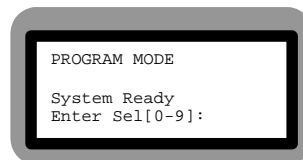

### Keypad Entry

### Detailed Descriptions

<b>0</b>	– System Identification Voice message ▼	(Page 85)
	– Numeric ID ▼	(Page 75)
	– System alpha ID	(Page 87)

<b>1</b>	– Access Code	(Page 61)
----------	---------------	-----------

<b>2</b>	– Ring Count	(Page 81)
----------	--------------	-----------

<b>3</b>	– Date and Time	(Page 69)
----------	-----------------	-----------

<b>4</b>	– System Delays Program to Run mode delay ▼	(Page 85) (Page 78)
	– Disarm to Arm delay ▼	(Page 70)
	– Arm/Disarm Relay List	(Page 66)

<b>5</b>	– Firmware Version	(Page 72)
----------	--------------------	-----------

<b>6</b>	– Reset to System Defaults	(Page 81)
----------	----------------------------	-----------

<b>7</b>	– Reset Counters	(Page 81)
----------	------------------	-----------

<b>8</b>	– Speaker Volume	(Page 83)
----------	------------------	-----------



## Program Phone Settings

Every channel in the Elite, except the Phone Fault and Relay channels, has a telephone list associated with it. To call-out to a phone or cell phone when an alarm occurs, you enter the number of the Telephone List that you want to use for that specific alarm.

By default, all channels are configured to use Telephone List 1, but you can change that as needed to any of the 16 lists. The referenced Telephone List has up to 16 numbers for the Primary times of day and 16 numbers for the Secondary times of day. Each day can be divided into two parts: one part uses the Primary phone numbers, and the other part uses the Secondary phone numbers.

Telephone List has 16 List Positions. To call a phone or cell phone, simply enter the phone number into the List Position desired. The phone number can include delays, waiting for a dial-tone and any key that can be pressed on a telephone keypad. Each phone number can be up to 50 numbers/characters in length.

NOTE 

- The Global Option provides a quick method to set all entries to a specific value.

**4**

to enter Phone Setup

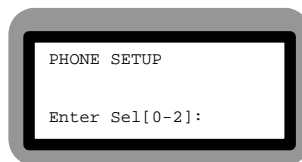

### Keypad Entry

### Detailed Descriptions

<b>0</b> – Primary or <b>1</b> – Secondary Phone List	(Page 78) or (Page 82)
– Phone List Number	(Page 77)
▼	
– Phone List Position	(Page 77)
▼	
– Phone Number	(Page 86)
▼	
– Next Call Delay	(Page 75)
▼	
– Notify Once	(Page 75)
▼	
– Call Progress	(Page 67)
Call Progress Delay	(Page 67)
<hr/>	
<b>2</b> – Call in Acknowledge	(Page 67)
▼	
– Redial After Acknowledge Delay	(Page 79)
▼	
– Message Repeat	(Page 74)

## Program Channel Settings

These settings affect the operation of the channel monitoring a sensor. These settings are typically adjusted during the initial installation, but can be modified at any time.

NOTE 

Press the # key to:

- move to the next program setting or
- to move up a level in the menu or
- to accept your entry

9

to enter Channel Configuration

Enter either a physical channel number or a Modbus channel number.

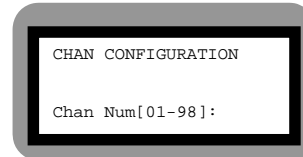

**NOTE:** Channel numbers are 2 digits, the first digit is the SLOT the second digit is the CHANNEL in the slot.

**NOTE:** The following steps are for Analog Inputs only. Digital Inputs and Relay Outputs are discussed later.

## Analog Inputs

Selections 0 through 6 allow you to modify the default settings or adjust any settings you desire. Full descriptions of each setting are found in the Glossary.

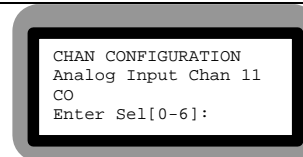

### Keypad Entry

### Detailed Descriptions

0

- |   |   |
|---|---|
| <ul style="list-style-type: none"> <li>- Input Type<br/>Specify if input is 4-20ma or voltage<br/>▼</li> <li>- Decimal Position<br/># of digits to the right of the decimal position.<br/>▼</li> <li>- Engineering Units<br/>Engineering units for this input.</li> <li>- Scale Input signal (yes or no)<br/>▼</li> <li style="padding-left: 20px;">- Zero Scale<br/>Value in eng. units at the lowest input level<br/>▼</li> <li style="padding-left: 20px;">- Full Scale<br/>Value in eng. units at the highest input level.<br/>▼</li> <li style="padding-left: 20px;">- Minimum Counts<br/>Value in counts of the minimum input<br/>(e.g. 4ma = 786 counts, count range 0-4095)<br/>▼</li> <li style="padding-left: 20px;">- Maximum Counts<br/>Value in counts of the maximum input</li> </ul> | <ul style="list-style-type: none"> <li>(Page 73)</li> <li>(Page 69)</li> <li>(Page 71)</li> <li>(Page 82)</li> <li>(Page 72)</li> <li>(Page 74)</li> <li>(Page 74)</li> </ul> |
|---|---|

(e.g. 20ma = 3931 counts, count range 0-4095)

---

**1** - Channel Message (Page 68)

▼  
Channel Alpha ID See How to Enter Text for Names page 25.

---

**2** - Channel Mode (Page 68)

0 - disabled, channel is not being used (Page 70)

1 - Status Only (Page 84)

2 - Call on Alarm (mode 0) (Page 63)

4 - Alarm Mode 2 (Page 63)

5 - Alarm Mode 3 (Page 64)

6 - Alarm Mode 4 (Page 64)

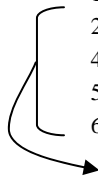

▼ Low Limit (0 - 999999999) (Page 74)

▼ High Limit (0 - 999999999) (Page 73)

▼ Positive Rate of Change (0-999999999) (Page 77)

▼ Negative Rate of Change (0 - 999999999) (Page 75)

▼ Rate of Change Period (0-60 minutes) (Page 79)

---

**3** - Alarm Delay (Page 62)

0 - as fast as the Elite can (about 210 ms)

---

**4** - Continue Notification if Return to Normal (Page 69)

---

**5** - Telephone List (Page 77)

Enter the phone list to use for alarm notification calls when this channel goes into the non-normal condition.

---

**6** - Relay List (Page 79)

Relay List to activate/de-activate going in/out of alarm.

---

---

## Relay Outputs

After you have entered a channel number that corresponds to a Relay Output, you have 3 options:

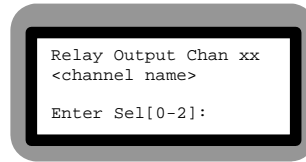

---

### Keypad Entry

### Detailed Descriptions

**0**

– Pulse Duration

(Page 78)

Amount of time the relay is energized until it automatically de-energizes.

(0 = the relay stays on)

---

**1**

– Channel Message

(Page 68)



Channel Alpha ID

See How to Enter Text for Names page 25.

---

**2**

– Channel Mode

(Page 68)

0 – disabled, channel is not being used

(Page 70)

1 – Status Only

(Page 84)

---

## Digital Inputs

After you have entered a channel number that corresponds to a Digital Input, you have 6 options:

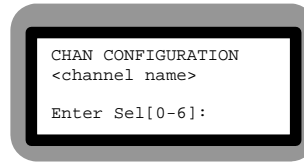

Keypad Entry	Detailed Descriptions
<p><b>0</b> - Channel State</p> <p>0 – Normally Open    1 – Normally Closed</p>	<p>(Page 68)</p> <p>(Page 75)</p>
<p><b>1</b> - Channel Message</p> <p>▼ Channel Alpha ID</p>	<p>(Page 68)</p> <p>See How to Enter Text for Names page 25.</p>
<p><b>2</b> - Channel Mode</p> <p>0 – disabled, channel is not being used</p> <p>1 – Status Only</p> <p>2 – Call on Alarm (mode 0)</p> <p>3 – Call on Limit</p> <p>▼ Totalizer Limit (0 – 999999999)</p> <p>▼ Duration Limit (0 – 999999999)</p> <p>▼ Limit Reset Period (0-999999 seconds)</p>	<p>(Page 68)</p> <p>(Page 70)</p> <p>(Page 84)</p> <p>(Page 63)</p> <p>(Page 67)</p> <p>(Page 87)</p> <p>(Page 70)</p> <p>(Page 73)</p>
<p><b>3</b> - Alarm Delay</p> <p>0 – as fast as the Elite can (about 210 ms)</p>	<p>(Page 62)</p>
<p><b>4</b> - Continue Notification if Return to Normal</p>	<p>(Page 69)</p>
<p><b>5</b> - Telephone List</p> <p>Enter the phone list to use for alarm notification calls when this channel goes into the non-normal condition.</p>	<p>(Page 77)</p>
<p><b>6</b> - Relay</p> <p>Relay to activate/de-activate going in/out of alarm.</p>	<p>(Page 79)</p>



---

## Relay List Setup

When any input goes into an alarm condition, a list of relays can be controlled. Each list can contain up to 9 physical relays (located in the same controller or communicated with via Modbus). There are a total of 98 Relay Lists available, numbered 1 to 98.

Initially, each physical relay is assigned to the Relay List of the same number. E.g. physical relay 41 would be the first relay in Relay List 41.

Using Relay Lists allows the user to define different relay activation combinations once and then reference the Relay List for several inputs. This is particularly useful for controlling multiple relays (like a light and a contact to a DCS system) for all inputs.

Relay Lists can be set up at anytime.

---

## Relay Operations

From the Program Mode.

There are 2 main operations available from the Relay function

7

- Activating/deactivating relays in a Relay List
- Assigning relays to a Relay List

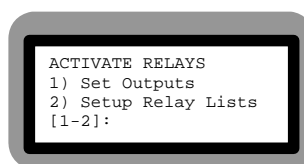

Press 2 to Setup List

---

### Keypad Entry

### Detailed Descriptions

---

2

- Relay List Setup

1-98 Relay List Number

(Page 80)



Relay List Position

(Page 80)



Relay Channel Number

(Page 79)

---



# Chapter 6: Modbus RTU Master

---

## Overview

The Modbus Master Interface enables the Elite to read input values from a Modbus sensor, PLC or Modbus Slave device and write relay control values to a Modbus sensor, PLC or Modbus Slave device. The connection uses the RS-232 serial connector on the Elite. The protocol is Modbus RTU, where the Elite is the Master and the Modbus sensors, PLC or Modbus I/O is the Slave.

The option supports a combination of up to 72 total I/O channels – up to 48 of which can be physical I/O in the Elite.

The I/O in the Modbus Slave can be any combination of analog (holding registers) or digital points (coils).

Values that are read from the Modbus Slave are interpreted by the Elite the same as if they were physical I/O in the Elite. All the alarm and control logic within the Elite operate on data coming from Modbus registers.

The communications link between the Elite and the Modbus slave devices is monitored several times a second. If the communications link stops functioning after repeated attempts, a Communications Channel (06) alarm is initiated. This alarm is treated exactly like any other system alarm allowing the system to call out, drive local relay or issue reports.

Ports 2 or 3 can be used as an RS-232 connection (DB9) or as a RS-485 connection (5-position plug). RS-232 Port 2 is J-11, RS-232 Port 3 is J-9 and RS-485 are both on J-17.

The RS-232 port is configured as a DTE device

Pin 2	RCV	Pin 3	XMT	Pin 5	GND
-------	-----	-------	-----	-------	-----

---

## Initializing the Modbus Master Interface

The Modbus Master Interface is setup by defining the:

- Serial port 2 or 3 can be selected as a Modbus Master– default baud rate is 38400
  - You can also set the Max Idle, Max Timeout and RS-232 or RS-485 mode
- Defining Elite I/O slots to be identified as Modbus I/O – default is that no slots are enabled as Modbus I/O slots.

There are 8 Modbus I/O channels per Slot. You can enable as many slots as you have purchased. For example, if you purchased a 32-channel Modbus Master configuration, then you can enable any 4 slots which do not have physical I/O cards attached.

All of these can be defined either through the integral keypad or remotely via a phone.

---

## Modbus Master Channel Setup

When you enter a channel number that is enabled as a Modbus channel, you see the display to the right.

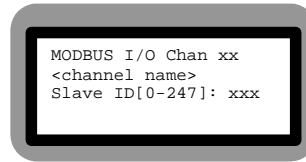

---

### Keypad Entry

### Detailed Descriptions

Slave ID (0 indicates read from an Elite channel)

(Page 83)



Register Type

(Page 79)



Register Number

(Page 79)

Enter Selection [0-7]

The remainder of the setup depends on the Register Type.

Register Type = Read Coil or Read Input Status then the remainder of the configuration is exactly like a Digital Input.

(Page 79)

Register Type = Write Coil then the remainder of the configuration is exactly like a Relay Output.

(Page 79)

Register Type = Read Holding , Read Input Register or Write Holding then the remainder of the configuration is exactly like an Analog Input.

(Page 79)

Register Type = Read Packed Bits then you must enter the specific Bit in the 16 bit word.

(Page 67)

## Modbus Master Port Setup

Port 2 or 3 is used as a Modbus Master port. It can be used as an RS-232 or RS-485 connection.

Set the port up through the Options Menu, Function 8.

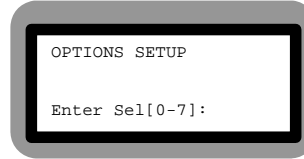

### Keypad Entry

### Detailed Descriptions

**1** or **2** - Port 2 or 3 Setup

Port Mode – set to 3 for Master	(Page 77)
▼	
Baud Rate	(Page 66)
▼	
Max Idle	(Page 74)
▼	
Max Timeout	(Page 74)
▼	
RS485	(Page 81)

## Mapping Elite Channels to Modbus Registers

I/O channels in the Elite are mapped to Modbus registers by providing three (3) pieces of information:

- **Modbus ID** – ID of the Modbus Slave
- **Register type** – which corresponds to Function Code
- **Register number** – number of the register for the particular Function Code

All of these items are entered in the Channel Configuration ( Function 9) section for each individual channel.

### Supported Register Types

Elite Register Type	Description	Type of channel in the Elite	Modbus Function Code
1	Read Coil Status	Digital	01
2	Read Input Status	Digital	02
3	Read Holding Register	Analog	03
4	Read Input Register	Analog	04
5	Write Coil (Set Coil)	Relay	05
6	Write Holding (Set Holding)	Analog	06
7	Read Packed (Read Bits)	Digital	03



# Chapter 7: Modbus RTU Slave

## Overview

The Modbus RTU interface allows the Elite to become a Modbus Slave device to communicate with any product that supports the Modbus Master protocol. Typical devices that support the Modbus Master protocol are:

- SCADA/HMI packages like: Wonderware, Intellution, Lookout, Bridgeview, FactoryLink, P-CIM, OI-2000 or a host of other products.

The Modbus Slave interface allows the SCADA/HMI software to read and write information into the Elite from:

- a direct connection via an RS-232 or RS-485 port
- a direct connect to the secondary RS-232 or RS-485 port if the Elite is also a Modbus Master or,
- over a modem.

The information available to the SCADA/HMI software is:

- Read current analog (sensor) channel values
- Read current relay channel states (energized/de-energized)
- Read current digital channel states (open/closed)
- Read current alarm state for each channel (in/out of alarm)
- Read current alarm acknowledge state (acknowledged/not acknowledged)
- Write relay channel (energize/de-energize)

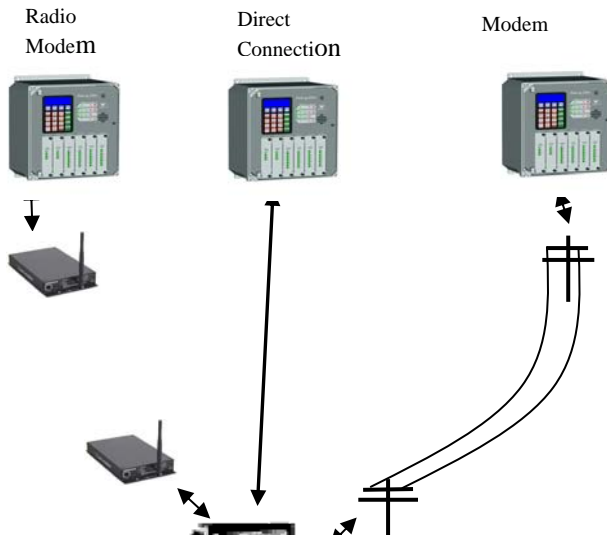

## Serial Port Settings

The Elite is configured to operate on one or more serial port set as follows:

<i>Figure 19 - Modbus RTU Slave connections</i>	
Parity:	None
Stop bits:	1
Flow control:	None

---

Port 2 or 3 is an RS-232 port configured as a DTE device

Pin 2    RCV                      Pin 3    XMT                      Pin 5    GND

---

## Modbus Slave Port Setup

Port 2 or 3 can be used as a Modbus Slave ports. Port 2 and 3 can be used as an RS-232 or RS-485 connection.

Set the port up through the Options Menu, Function 8.

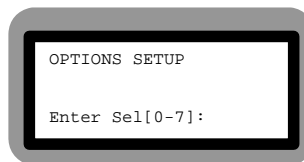

---

### Keypad Entry

### Detailed Descriptions

---

**0** - Port 1 Setup – GSM cell phone (only if installed)

Port Mode – set to 2 for Slave	(Page 77)
▼	
Baud Rate	(Page 66)
▼	
Max Idle	(Page 74)
▼	
Max Timeout	(Page 74)

---

**1** OR **2** Port 2 or 3 Setup

Port Mode – set to 2 for Slave	(Page 77)
▼	
Baud Rate	(Page 66)
▼	
Max Idle	(Page 74)
▼	
Max Timeout	(Page 74)
▼	
Modbus ID	(Page 74)
▼	
RS-485 enable	(Page 81)

---

---

## Modem Settings

The Elite is configured to operate with a modem set as follows:

Init string                      X2

---

## Modbus Slave ID

The default Slave ID is 126. This is adjustable from the Options Menu page 76 (depending on which port is going to be used)



---

## Register Mapping

The Elite Modbus Slave interface supports 2 methods of reading/writing register values.

- Read/write in counts (legacy systems support this method)
- Read/write in unscaled engineering units

The following defines the mapping for values in counts:

0xxxx	(R/W) coils (relays in the Elite)
1xxxx	(R) input status (digital inputs, alarm state, acknowledge state)
4xxxx	(R/W) holding registers (analog inputs, digital totalizers, digital duration counters)

The Modbus function codes that are supported by the Elite are:

Function Code	Description
1	Read coil status
2	Read input status
3	Read holding register
5	Force a single coil
6	Preset a holding register
15	Force multiple coils
16	Preset multiple holding registers

If a slot is empty, does not have the correct I/O type or a channel is disabled on the Elite, then a '0' will be returned for that corresponding register.

The following mapping returns values in unscaled engineering unit values.

---

### Coils (0xxxx) Relays (Read/Write)

---

All relay types in the Elite are represented via relay lists, i.e. physical, MODBUS read coil, and MODBUS write coil.

By default, a physical relay, read coil or write coil channel is assigned to the list having the same number as that channel. For example, if there is a relay card in slot 4, then relay channel 41 is put into list number 41, relay channel 42 is put into list 42, and so on.

If a MODBUS write coil is in channel 83, then that channel is put into relay list 83. If a read is done from these register addresses, a 0 will be returned unless there is a physical relay at the requested address.

A value of '1' indicates the relay is to be energized or is already energized, '0' indicates the de-energized condition.

---

**Modbus Address**

**Elite I/O channel**

---

(0)0101-(0)0108	Slot 0, Chan1-8 (N/A) (or relay lists 1-10)
(0)0111-(0)0118	Slot 1, Chan 11-18 (or relay lists 11-20)
(0)0121-(0)0128	Slot 2, Chan 21-28 (or relay lists 21-30)
(0)0131-(0)0138	Slot 3, Chan 31-38 (or relay lists 31-40)
(0)0141-(0)0148	Slot 4, Chan 41-48 (or relay lists 41-50)
(0)0151-(0)0158	Slot 5, Chan 51-58 (or relay lists 51-60)
(0)0161-(0)0168	Slot 6, Chan 61-68 (or relay lists 61-70)
(0)0171-(0)0178	Slot 7, Chan 71-78 (or relay lists 71-80)
(0)0181-(0)0188	Slot 8, Chan 81-88 (or relay lists 81-90)
(0)0191-(0)0198	Slot 9, Chan 91-98 (or relay lists 91-98)

### Input Status (1xxxx) Digital Inputs (Read Only)

A return value of '1' indicates the specified channel is closed, a value of 0 indicates the channel is open.

Modbus Address	Elite I/O channel
(1)0001-(1)0008	Slot 0 Digital Inputs (not applicable)
(1)0009-(1)0016	Slot 10 Digital Inputs
(1)0017-(1)0024	Slot 20 Digital Inputs
(1)0025-(1)0032	Slot 30 Digital Inputs
(1)0033-(1)0040	Slot 40 Digital Inputs
(1)0041-(1)0048	Slot 50 Digital Inputs
(1)0049-(1)0056	Slot 60 Digital Inputs
(1)0057-(1)0064	Slot 70 Digital Inputs
(1)0065-(1)0072	Slot 80 Digital Inputs
(1)0073-(1)0080	Slot 90 Digital Inputs

### Holding Registers (4xxxx) Analog Inputs or Modbus Analog Inputs (Read Only)

The following addresses represent scaled analog inputs and scaled MODBUS holding register values and are accessible via a single register read. They are scaled to the zero and full scale for the given channel.

Getting the correct reading requires placing the decimal point to match the decimal point parameter for that channel. The range of values in these registers is -32767 to +32767.

If you know the value will never exceed this range, read from these registers. If the value is too large to fit in a single register, a value of -9999 is returned. For values larger than this range, use the double register read method described below.

<b>Modbus Address</b>	<b>Elite I/O channel</b>
(4)0101-(4)0108	Slot 0 Analog Input
40101	Primary Power (0-17.2V)
40102	Battery Power (0-17.2V)
40103	Phone Fault (0-good, 1-fault)
40104	Elite Temperature (-20 - +60C)
40105	spare
40106	Communications (0 – Normal, 1 – alarm)
40107	System Fault (0 – Normal, 1 – alarm)
(4)0109-(4)0116	Slot 10 Analog Input (or Modbus Analog Input)
(4)0117-(4)0124	Slot 20 Analog Input (or Modbus Analog Input)
(4)0125-(4)0132	Slot 30 Analog Input (or Modbus Analog Input)
(4)0133-(4)0140	Slot 40 Analog Input (or Modbus Analog Input)
(4)0141-(4)0148	Slot 50 Analog Input (or Modbus Analog Input)
(4)0149-(4)0156	Slot 60 Analog Input (or Modbus Analog Input)
(4)0157-(4)0164	Slot 70 Analog Input (or Modbus Analog Input)
(4)0165-(4)0172	Slot 80 Analog Input (or Modbus Analog Input)
(4)0173-(4)0180	Slot 90 Analog Input (or Modbus Analog Input)

### **Holding Registers (4xxxx) Scaled Analog Inputs or Modbus Analog Inputs (Read Only)**

The following addresses represent scaled analog inputs and scaled MODBUS holding register values and are accessible via double register reads.

They are scaled to the zero and full scale for the given channel. Getting the correct reading requires placing a decimal point to match the decimal point parameter for that channel. The value for a given channel is requested by reading two consecutive registers.

A read to an odd register returns the high word of the value.

A read to an even register returns the low word of the value.

The range of the double register is –2147483647 to +2147483647. If you know the value in the register will never exceed –32767 to +32767, you may read the even register (low word) only, or use the single register read method described above.

Example: To read the scaled engineering value from slot 3, channel 5, read from MODBUS registers 1057 and 1058.

<b>Modbus Address</b>	<b>Elite I/O channel</b>
(4)1001 -(4)1016	Slot 0, Chan1-8 (N/A)

(4)1017 -(4)1032	Slot 1, Chan 11-18
(4)1033 -(4)1048	Slot 2, Chan 21-28
(4)1049 -(4)1064	Slot 3, Chan 31-38
(4)1065 -(4)1080	Slot 4, Chan 41-48
(4)1081 -(4)1096	Slot 5, Chan 51-58
(4)1097 -(4)1112	Slot 6, Chan 61-68
(4)1113 -(4)1128	Slot 7, Chan 71-78
(4)1129 -(4)1144	Slot 8, Chan 81-88
(4)1145 -(4)1160	Slot 9, Chan 91-98

## Read Input Status (1xxxx) Alarm State and Acknowledge State

---

Alarm State – a returned value of ‘1’ indicates the specified channel is in alarm, a return value of ‘0’ indicates the channel is not in alarm.

Acknowledge State - a returned value of ‘1’ indicates the specified channel is in alarm and acknowledged, a return value of ‘0’ indicates the channel is not acknowledged regardless of the alarm state.

<b>Alarm State Modbus Address</b>	<b>Elite I/O channel</b>	<b>Acknowledge State Modbus Address</b>
(0)0101-(0)0108	Slot 0, Chan 1-8	(0)0201-(0)0208
(0)0109-(0)0116	Slot 1, Chan 11-18	(0)0209-(0)0216
(0)0117-(0)0124	Slot 2, Chan 21-28	(0)0217-(0)0224
(0)0125-(0)0132	Slot 3, Chan 31-38	(0)0225-(0)0232
(0)0133-(0)0140	Slot 4, Chan 41-48	(0)0233-(0)0240
(0)0141-(0)0148	Slot 5, Chan 51-58	(0)0241-(0)0248
(0)0149-(0)0156	Slot 6, Chan 61-68	(0)0249-(0)0256
(0)0157-(0)0164	Slot 7, Chan 71-78	(0)0257-(0)0264
(0)0165-(0)0172	Slot 8, Chan 81-88	(0)0265-(0)0272
(0)0173-(0)0180	Slot 9, Chan 91-98	(0)0273-(0)0280

---

## Error Returns

If the Elite detects an error in the request, then the following standard Modbus exceptions are returned:

<b>Condition</b>	<b>Exception returned</b>	<b>Exception Code</b>
Register address is out of range or the starting address plus the number of registers exceeds the address range of the Elite.	ILLEGAL_ADDRESS	2
Number of registers requested is too large, i.e. beyond the range of the Elite	ILLEGAL_VALUE	3
Unsupported function code is received.	ILLEGAL_FUNCTION	1
If the slave cannot respond because the response message is too large (too much data was asked for)	SLAVE_DEV_FAILURE	4



## Chapter 8: PC/Laptop Access

The Elite can be accessed from a PC or laptop to view the current status of all channels, view the event log, modify programming, etc.

The connection to the Elite is via the serial RS-232 port 2 or port 3



If using serial port 2 or 3, it must be in the Diagnostics mode, which means it cannot be used when the Elite is also active as a Modbus Master or Slave.

Follow these steps to bring up the Diagnostics Menu:

- |    |  |   |
|----|--|---|
| 1. | Set serial port baud rate              | PROG 8 <serial port> (for the port that you are going to use) |
| 2. | Enable diagnostics port                | Set the Port Mode to 1 (diagnostics)                          |
| 3. | Connect your serial cable (null modem) |   |
| 4. | Press the ENTER key                    | “Password:” is displayed                                      |
| 5. | Enter the password                     | DialogElite   |
| 6. | The following menu is displayed        |   |

The following is the main menu and Site setup sub-menu as shown from Hyperterminal (under Accessories > Communication in Windows)

```

Password: XXXXXXXXXXXX

10/31/07  10:50
Antx, Inc.  Dialog Elite

0) View Config
1) View Chan
2) System State
3) Chan Data
4) Event Log
5) Timers
6) Preset Counters
7) Status Reports
8) Set Outputs
9) Site Setup
10) System Maint.

Cmd => 9

*****  Site Setup  *****

1) System
2) Channels
3) Relay Lists
4) Comm Ports
5) MBUS Slot Enable

...>
*****  Channels  *****

1) View
2) Config
3) Copy
4) Reset to Defaults
5) View MODBUS
6) View Devices

```

```

...> 2
***** Channels *****

1) View
2) Config
3) Copy
4) Reset to Defaults
5) View MODBUS
6) View Devices

...> 3
***** Relay Lists *****

1) View
2) Config
3) Clear List
4) Clear All Lists

```

The following is the Channel Configuration to view or program for an analog input.

```

*** Channel Configuration ***

Chan# [01-98]: 11
Chan Name: Chan 11
Type [0-5]: 5 (4-20mA)
Decimal Position [0-5]: 1
Engineering Units [0-34]: 0 (...)
Scale Value [0-1]: 1
Zero Scale [-999999999-999999999]: 0 (+0.0 )
Full Scale [-999999999-999999999]: 1000 (+100.0 )
Zero Scale Counts [-65535-65535]: 786
Full Scale Counts [-65535-65535]: 3931
Mode [0-6]: 6 (Call On Alarm 4)
Alarm Delay (secs) [0-65535]: 3
Phone List [1-16]: 1
Call On Return To Normal [0-1]: 0
Low Alarm Limit [-999999999-999999999]: -1 (...)
High Alarm Limit [-999999999-999999999]: -1 (...)
+Rate of Change Limit [-1-999999999]: -1 (...)
-Rate of Change Limit [-1-999999999]: -1 (...)
Rate of Change Interval (mins) [0-60]: 0
Low Alm Relay List# [0-99]: 0 22
Low Alm Relay List# [0-99]: 22
  Pos 1 2 3 4 5 6 7 8 9
      00 00 00 00 00 00 00 00 00
  Low Alm State [0-2]: 1 (On)
  Low Norm State [0-2]: 0 (Off)
High Alm Relay List# [0-99]: 0 23
High Alm Relay List# [0-99]: 23
  Pos 1 2 3 4 5 6 7 8 9
      00 00 00 00 00 00 00 00 00
  High Alm State [0-2]: 1 (On)
  High Norm State [0-2]: 0 (Off)
Relays Off On Ack [0-1]: 0

```



## Chapter 9: Datalogging

The Elite Data Logging option can log up to 10,000 separate time-stamped data values. The data is formatted in either a comma-separated value (CSV) or ASCII tabular format.

When datalogging is enabled, the Elite logs ALL analog channels that are NOT disabled.

The data can be accessed via a direct serial connection to the RS-232 port when in Diagnostics mode (as discussed in the previous chapter) or via a modem Hyperterminal or other terminal emulation connection.

The following is the main menu and Show Data Log sub-menu.

```
Password: XXXXXXXXXXXX

Elite
Version: 4.0.0 05/03/06

00) Show System Config
01) Show Chan Config
02) Show System State
03) Show Chan Data
04) Show Event Log
05) Data Logging
06) Timers
07) Preset Counters
08) Status Reports
09) Set Outputs
10) Pump Cycles
11) Site Setup

Cmd => 5

***** Data Log *****
Data Logging: enabled

1) View Data Log
2) Clear Data Log
3) Set Start/Interval

...>
Start Time: 00:00
New Start Time [00:00:00]:
Interval(mins) [0-1440]:
Format [0=ASCII/1=CSV]:

...>
Hit ESC to stop...

1,05/26/04 14:48:00,22,West-CO,20,ppm
2,05/26/04 14:48:00,21,Storage-O2,20.4,%vol
3,05/26/04 14:46:00,22,West-CO,20,ppm
4,05/26/04 14:46:00,21,Storage-O2,20.4,%vol
5,05/26/04 14:44:00,22,West-CO,19,ppm
6,05/26/04 14:44:00,21,Storage-O2,20.5,%vol
7,05/26/04 14:42:00,22,West-CO,20,ppm

1 05/26/04 15:12:00 22 West-CO 20 ppm
2 05/26/04 15:12:00 21 Storage-O2 20.5 %vol
3 05/26/04 15:10:00 22 West-CO 20 ppm
4 05/26/04 15:10:00 21 Storage-O2 20.4 %vol
5 05/26/04 15:08:00 22 West-CO 19 ppm
6 05/26/04 15:08:00 21 Storage-O2 20.4 %vol
```

Start Time shows the current setting to begin logging.  
New Start Time is [HH:MM:SS] in military time  
Interval is minutes between recorded values.

CSV format example

ASCII format example



## Chapter 10: Glossary

---

Abort Phone Call	Pressing the HOME key while a call is in progress will immediately cancel the call.
------------------	---

---

Access Code	<p>A 4-digit code that can be entered to prevent any unauthorized personnel from entering the Programming Mode.</p> <p><b>NOTE:</b> When entering Programming Mode, either locally or remotely, the access code must be entered.</p>
-------------	--

---

Accumulated Time	<p>The Digital Input card can be used to accumulate, or add up, all the time that the input signal has been in the On, or non-normal, state. The accumulator adds all the seconds for each time the signal goes into the On state. You program the limit for this condition using the <i>Duration Limit</i> under the <i>Channel Configuration</i> for the specific channel being monitored.</p> <p>Time is reported and displayed as Days Hours:Minutes:Seconds.</p> <p>Accumulated time is reported as Days, Hours, Minutes and Seconds.</p>
------------------	--

---

Acknowledge Alarms	<p><b>Locally:</b></p> <p>Press the ACK key on the keypad while the Elite is in RUN mode.</p> <p><b>When Called:</b></p> <p>At a remote telephone, when you receive an alarm notification call, Elite delivers the message, says “Please acknowledge”, and waits 5 seconds for you to enter the 8, 9 or * to acknowledge an alarm.</p> <p>If is not necessary to listen to the entire message before acknowledging the alarm. You may enter the <b>8</b>, <b>9</b> or <b>*</b> at any time.</p> <p>If the Elite does receive an acknowledgement it immediately responds with “Alarm acknowledged. You have 60 minutes to clear the alarm”, beeps three (3) times and waits 5 seconds for you to press <b>#</b> to enter the programming mode. You may program the Redial after Acknowledge Delay for another value other than 60 minutes.</p> <p>If Elite does not receive an acknowledgment key, it repeats “Please acknowledge” and waits another 5 seconds. It repeats this message sequence and then hangs up and waits for a return call or goes to the next phone number in the list.</p> <p><b>When Calling In:</b></p> <p>If a person calls in to the Elite while any alarms are active, the alarms are acknowledged according the Call In Acknowledge setting. (Page 67)</p> <p><b>NOTE:</b> When alarms are acknowledged, any alarm notification call-outs are stopped.</p>
--------------------	---

---

Acknowledge Input Channel	A digital input channel can be used to acknowledge alarms. When this channel goes into the non-Normal condition, it will acknowledge all active alarms.
---------------------------	---

---

AK	Shown on the display and in reports. Indicates the channel is in alarm and has been acknowledged.
----	---

---

AL	Shown on the display and in reports. Indicates the channel is in alarm.
----	---

---

Alarm Calls	<p>When an alarm call is made from the Elite, the process is as follows:</p> <ol style="list-style-type: none"> <li>1. Elite waits for a 3-second Alarm Delay period to make sure the channel is actually in alarm, and then begins alarm call-outs. The Alarm Delay period can be adjusted.</li> <li>2. The front panel alarm indicator for the channel in alarm begins to blink <b>red</b> and the PHONE STATUS indicator goes steady <b>green</b>, indicating Phone Off Hook.</li> <li>3. Elite automatically dials the first number on Telephone List 1, although you can program the system to dial a different list of numbers. You can program up to 16 lists of 16 numbers and assign each digital input channel to any one of the lists. This way, you can target alarms to specific destinations. For example, you can direct cooling and heating failures to your mechanics, hazardous material leakage to emergency teams, and intrusion alarms to security. Alarms are prioritized by their Telephone List number, with List 1 the highest and List 16 the lowest.</li> <li>4. Elite rings the first number on the Telephone List for up to 60 seconds. If the line is busy or the telephone is not answered during the 60-second period, the system dials the second number. It repeats this sequence until someone answers.</li> <li>5. When the call is answered, Elite identifies itself by speaking the Site ID message, delivers the message for the channel in alarm, and says "Please acknowledge." It repeats this sequence three times. You can change the number of Message Repeats.</li> <li>6. The person answering the call acknowledges the alarm by pressing the <b>*</b> or <b>8</b> or <b>9</b> key on a Touch-Tone telephone within 5 seconds after Elite requests an acknowledgement.</li> </ol>
Alarm Code	<p>The Elite uses alarm codes on the display, status reports and alphanumeric pager alarms to indicate the condition of an alarm or input</p> <p>OP – open on a digital input  CL – closed on a digital input  CM – communication alarm on a Modbus input/output  OL – open-loop condition on an analog input  TL – totalizer limit alarm on a digital input  DL – duration limit alarm on a digital input  LO – low limit alarm on an analog input  HI – high limit alarm on an analog input  -R – negative rate of change alarm on an analog input  +R – positive rate of change alarm on an analog input</p>
Alarm Delay	<p>The amount of consecutive seconds an input needs to exceed a Limit before it goes into alarm. [0-65535 seconds] (default is 3 seconds)  Channel LED blinks green during this time.</p>
Alarm message	<p>A 6-second message can be recorded for the alarm condition for each channel. This message is spoken when the channel is in alarm and the Elite calls out or a user calls-in for status.</p> <p><i>To Change</i>    <b>PROG 9 &lt;chan num&gt; # # # 1</b></p>

---

Alarm Mode 0

This mode defines a normal region that is above the Low Limit and below the High Limit.

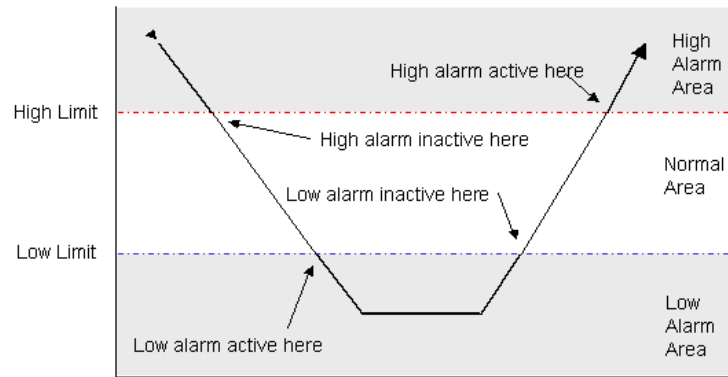

Channel Mode – **Call on Alarm**

- On Low alarm active – alarm call out and Low relay list activation
- On High alarm active – alarm call out and High relay list activation
- On Low alarm inactive – Low relay list deactivation
- On High alarm inactive – High relay list deactivation

---

Alarm Mode 2

This mode defines a normal region that is above a Low and High Limit. The Low Limit is below the High Limit.

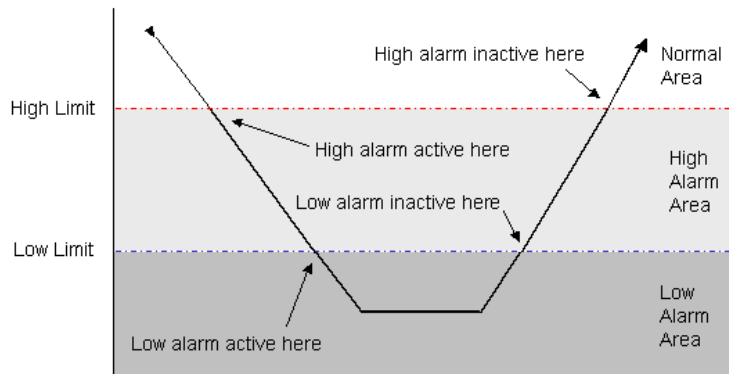

Channel Mode – **Call on Alarm Mode 2**

- On Low alarm active – alarm call out and Low relay list activation
  - On Low alarm inactive – Low relay list deactivation
  - On High alarm active – alarm call out and High relay list activation
  - On High alarm inactive – High relay list deactivation
-

---

Alarm Mode 3

This mode defines a normal region that is below a Low and above a High Limit.

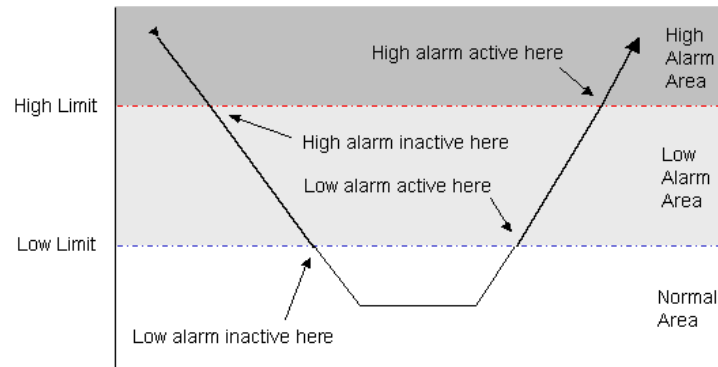

Channel Mode – **Call on Alarm Mode 3**

- On Low alarm active – alarm call out and Low relay list activation
- On Low alarm inactive – Low relay list deactivation
- On High alarm active – alarm call out and High relay list activation
- On High alarm inactive – High relay list deactivation

---

Alarm Mode 4

This mode defines 2 normal operating regions, one above a High Alarm Limit and one below a Low Alarm Limit.

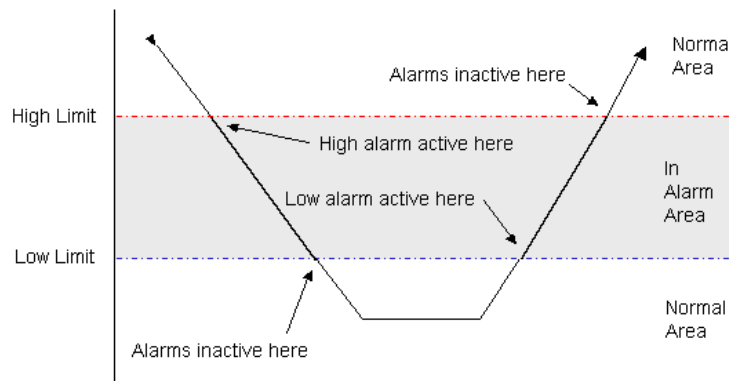

Channel Mode – **Call on Alarm Mode 4**

- On Low alarm active – alarm call out and Low relay list activation
- On High alarm active – alarm call out and High relay list activation
- On Alarms inactive – Low and High relay list deactivation

---

Alarm Screen

When any channel goes into an alarm state, the display is automatically changed to show the current conditions of those channels. The user has the option to Pause on a channel of interest to view all relays which are being controlled by that channel.

---

Alarm State

When a sensors value exceeds a Low or High Limit, the channel goes into an Alarm State. When these transitions occur, Relay Lists can be controlled. Specify what condition you want the relay to assume when these transitions occur.

0 – Deenergized

1 – Energized

2 – No change (disabled)

Alarm Types	<p>Input alarms are generated from either Digital Inputs or Analog Inputs.</p> <p>The Digital Inputs have three types of alarms:</p> <ul style="list-style-type: none"> <li>• Contact closure (or open)</li> <li>• Totalizer (counting pulses)</li> <li>• Duration (total time in a condition)</li> </ul> <p>Analog Inputs have 4 types of alarms:</p> <ul style="list-style-type: none"> <li>• High limit</li> <li>• Low limit</li> <li>• Positive rate of change</li> <li>• Negative rate of change</li> </ul> <p>Each of these alarms is independent of the other.</p>
pager call	<p>Alphanumeric pager calls are made to modems at the pager company. The Elite communicates to the pager company utilizing the TAP protocol.</p> <p>To call out to an alphanumeric pager, put the AlphaPager code (*5) (displays the letter 'A'). The Elite calls the number and, when answered, delivers the following message:</p> <p><i>(Alphanumeric System Identification) (Channel Name)</i>  (Alarm Code) (Current analog value) (Analog engineering units)</p> <p>A telephone list entry for an alphanumeric pager phone number includes the:</p> <p>(pager company modem number)(*5)(alphanumeric pager ID)</p> <p>Example: 5123456789A2086158</p> <p>The *5 tells the Elite to wait until a connection to the pager company's modem is made before issuing the alphanumeric pager ID.</p> <p>Be sure you confirm with the pager company your actual pager ID. Some systems use a 7-digit code, some an 8-digit code with the first digit always being 0, and others have a 10-digit code.</p>
Amber LED	<p>Channels LEDs can be amber, which indicates that the input is in the Low Alarm region. Blinking indicates in alarm and Not acknowledged, solid indicates in alarm and acknowledged. (Available on Elite controllers only)</p>
Analog Input	<p>Analog inputs are voltage or current inputs that vary over a pre-defined range. Typically 4-20ma or 1-5V. These signals are connected to Analog Input cards and programmed to provide values in engineering units.</p> <p>Elite operates on analog inputs in engineering units, not counts. Since you are measuring in engineering units, this makes it easier to specify the alarm limits that you use. You specify the conversion from current (ma) or voltage (V) to engineering units using the Decimal Position, Zero Scale, Full Scale, and Engineering Units under the Channel Conversion.</p> <p>Use the Zero to specify the Engineering Unit value at the lowest input signal being monitored. The Full Scale is the range of the input signal in Engineering Unit value. The Digits to the right of the decimal is used to specify the precision of all the limits, zero, and span. The Zero Sign specifies whether the zero value is negative or positive.</p> <p>If the Engineering Unit is set to gpm (gallons per minute) or gph (gallons per hour), the Elite automatically computes a totalized flow. The totalized flow is displayed on the View channel screen and on Status reports. The totalized flow will continue to increase until the counter is reset using the Reset Counter function.</p>

Analog Input Offset Factor	<p>This factor together with the Analog Input Scaling Factor allow the user to adjust an entire analog input card to match a calibrated source. The offset corresponds to the zero adjustment.</p> <p><b>NOTE:</b> these are preset at the factory and typically never adjusted in the field</p>
Analog Input Scaling Factor	<p>This factor together with the Analog Input Scaling Factor allow the user to adjust an entire analog input card to match a calibrated source. The scaling factor corresponds to the slope adjustment.</p> <p><b>NOTE:</b> these are preset at the factory and typically never adjusted in the field</p>
Arm	<p>ARMed mode is signified by a green RUN LED. In this mode the Elite is monitoring all inputs and performing all alarm functions.</p>
Arm/Disarm Relay List	<p>A relay list that is activated whenever the Elite is Disarmed and de-activated whenever the Elite is Armed.</p>
Audio Settings	<p>Adjustable speaker volume</p> <p>0 – Off            1 – Low (default)            2 – Med            3 – High</p>
Backup	<p>See Reset to System Defaults</p>
Battery Backup	<p>The standard 12 VDC internal backup battery maintains operating power to Elite for a minimum of 24 hours at 86°F in case of primary power loss. The switchover to battery operation is automatic; no operator intervention or reprogramming is required.</p> <p>An alarm notification call alerts the first available person on the telephone list specified for the Power Fail Alarm with the message, “Channel 0 is in alarm; system on battery backup.”</p> <p>The POWER STATUS indicator on the front panel changes from a steady green light to a blinking red light, indicating that the system is now on battery power and the Primary Power alarm has not yet been acknowledged.</p> <p>If the battery charge drops below a certain level, the message “System battery is low” is delivered in the System Status report, and the BATTERY STATUS indicator blinks red, indicating that the Low Battery alarm is active and has not yet been acknowledged.</p> <p>While primary power is available, the BATTERY STATUS indicator blinks green when the internal battery is charging. The battery requires 20 hours to recharge completely.</p> <p>If the battery fails to take a charge while the system is operating from primary power, the System Status report includes the message, “System battery is bad.” When you hear this message, we strongly recommend that you replace the battery.</p>
Battery Channel	<p>Channel 02 – monitors the backup battery voltage. This voltage is typically 12VDC. Low and High alarm limits can be specified for alarm relay activation or call outs. The battery is automatically charged when necessary. The Battery LED indicates if the battery is fully charged (green), being charged (green blinking), or in alarm (red and red blinking).</p>
Baud Rate	<p>The serial port baud rate for communication as a Modbus Master, Slave or a diagnostics/programming port.</p>



Between Call Delay	The amount of time to wait after completing this call until the next phone number is dialed. [0-3600 seconds] (default is 30 seconds)
Bits	A Read Packed Bits operation reads a 16-bit word from the Modbus Slave device. The Elite can extract a single bit from a Holding Register and use that as the input to a digital input channel.  The Elite numbers the bits from 1 to 16, with 1 being the least significant bit.
Bksp key	Delete the character just entered.
Blinking LEDs	Indicates the channel has an un-acknowledged alarm.
Call in Acknowledge	Determines if alarms are acknowledged when a person calls into the Elite. 1 – Automatic (default) – all alarms are acknowledged on call in 2 – Customer Acknowledge – asks for which phone list of alarms to acknowledge
Call on Limit	Available on Digital Inputs only. Provides a count of the number of times the input has gone from normal to non-normal (totalizer) and computes the total time that the input has stayed in the non-normal condition (duration). You do not have to specify any alarm limits for the totalizer and duration.  The Duration is typically used to provide a Run-Time meter. If a Duration Limit is specified, then alarm calls or relay activation occurs when the Duration value meets the Duration Limit. For example, if you wanted to know when a motor had run 100 hours, then you would specify the Duration Limit to be 100 hours or 360,000 seconds.  The Totalizer is a counter and is typically used for Pump or Motor Cycle counting. If a Totalizer Limit is specified, then alarm calls or relay activation occurs when the Totalizer value meet the Totalizer Limit – typical uses are to be notified if a pump cycles too often in a day.  For example, if you wanted to be notified if a lift station pump cycled on more than 15 times in a day, you would set the Totalizer Limit to 15 and the Limit Reset Period to 1440 minutes.
Call Progress	If Call Progress is enabled (1), the Elite waits until the phone has been answered before delivering the alarm message.  If disabled (0), the Elite calls the number, waits the Call Progress Delay number of seconds and then delivers the alarm message.
Call Progress Delay	Number of seconds the Elite waits after dialing the last digit of the Phone Number before the alarm or status message is delivered.
Caller ID	If the phone line that is used by the Elite has Caller ID enabled from the local phone company, then the Elite records the Caller ID of every call it receives in the Status Log. This includes calls that are received by the Elite for alarm acknowledgement.
Cancel phone call	When a call is in progress, it can be cancelled by pressing the HOME key.
Channel Conversion	Sub-menu to set conversion parameters for an analog input channel.  Input Type, Decimal Position, Zero Scale, Full Scale, Engineering Units

Channel message	A 6-second message can be recorded for each channel. This message is spoken when an alarm call is made or when someone calls in for status of this channel. The message is recorded using the Microphone.
Channel Mode	Indicates whether the channel is Disabled, Status Only or one of the Alarm modes. <ul style="list-style-type: none"> <li>Disabled (0)      the LED is out and the channel is not being scanned or processed</li> <li>Status Only (1)    Digital and Analog - the LED is always green and the channel is being scanned, but not evaluated for alarms Relay – the channel is active and can be energized or de-energized</li> <li>Call on Alarm (2)    Digital – goes into alarm when the channel goes from the Normal setting to the Non-normal setting (e.g. from Open to Closed on a Normally Open channel) Analog - goes into alarm when the value exceeds either the Low or High Limits.</li> <li>Alarm Mode 2 (4)    Analog – defines a normal region that is below a Low and above a High Limit. Goes into alarm when the value exceeds the Low or High Limit. The LED goes Amber when it exceeds the Low limit and goes Red when it exceeds the High limit.</li> <li>Alarm Mode 3 (5)    Analog - defines a normal region that is below a Low and above a High Limit. Goes into Low alarm when the value falls below the Low limit. Goes into High alarm when the value exceeds the High limit. The LED goes Amber when the value falls into the Low limit and goes Red when the value exceeds the High limit.</li> <li>Alarm Mode 4 (6)    Analog - defines 2 normal operating regions, one above a High Alarm Limit and one below a Low Alarm Limit. The LED goes Amber if the value transitions from the lower Normal region to above the Low limit. The LED goes Red if the value transitions from the upper Normal region to below the High limit.</li> </ul>
Channel Name	A 20-character name associated with a channel.
Channel State	Define the input as being Normally Open (0) or Normally Closed (1). <p>A signal connected to the (IN) connection of a Digital Input is considered Open when its voltage is less than 3.5VDC.</p> <p>A signal connected to the (IN) connection of a Digital Input is considered Closed when the voltage is greater than 5.0VDC</p>
Clear key	Clear the current value being entered from the keypad.
CM	Shown on the display and in reports. Indicates there is a Communications error between the Elite and a Modbus device. <p>Confirm that the cable is connected, the baud rate is correct, the Modbus ID and register number are correct.</p>
Communication Channel	Channel 06 – monitors Modbus Master communication out the serial port 2 and 3, as a RS-232/or RS-485 port. If communication fails, this channel goes into alarm. Typical causes for failure are: baud rate mismatch, incorrect Modbus Slave ID, incorrect Modbus Slave register number

Continue alarm notification if return to normal	<p>If enabled, the channel must be acknowledged upon its return to the normal condition. The Elite calls when the channel goes into alarm and again when the channel returns to the normal condition.</p> <p>Both the alarm and continue notify calls need to be acknowledged.</p>										
Datalogging	<p>Datalogging is an option that can be purchased. This option allows up to 10,000 analog points to be continually logged at a user specified interval from 1 to 1440 minutes. All enabled analog inputs are logged at the same interval. The data can be retrieved via a direct serial or modem connection.</p>										
Date/Time	<p>Specify the current date and time and the format of the date and time.</p> <p>The valid formats for the date and time are:</p> <table> <tr> <td>0</td> <td>mm/dd/yy hh:mm:ss (default)</td> </tr> <tr> <td>1</td> <td>yy/mm/dd hh:mm:ss</td> </tr> <tr> <td>2</td> <td>dd.mm.yy hh:mm:ss</td> </tr> <tr> <td>3</td> <td>dd/mm/yy hh:mm:ss</td> </tr> <tr> <td>4</td> <td>dd mm yy hh:mm:ss</td> </tr> </table>	0	mm/dd/yy hh:mm:ss (default)	1	yy/mm/dd hh:mm:ss	2	dd.mm.yy hh:mm:ss	3	dd/mm/yy hh:mm:ss	4	dd mm yy hh:mm:ss
0	mm/dd/yy hh:mm:ss (default)										
1	yy/mm/dd hh:mm:ss										
2	dd.mm.yy hh:mm:ss										
3	dd/mm/yy hh:mm:ss										
4	dd mm yy hh:mm:ss										
Day	<p>Specifies a day of the week or a holiday.</p> <p>1 – Sunday through 7 – Saturday, 8 – Holiday list</p>										
Decimal Position	<p>Number of digits to the right of the decimal. The default is 1, but can be adjusted from 0 to 9.</p> <p>For example, if the Decimal Position is 3, then values are presented as: xx.xxx</p>										
De-energize on alarm acknowledge	<p>If enabled, the relays energized for this alarm condition are de-energized when the alarm is acknowledged. (default is disabled)</p>										
Diagnostics port	<p>If enabled, then the serial ports can be connected to a laptop or PC for viewing diagnostics (status, event log, etc.) or for programming.</p> <p>The laptop/PC should use Hyperterminal or some other terminal emulation program.</p> <p>When connected, press the Enter key and the “Password:” prompt is displayed. The password is “DialogElite”.</p> <p>A menu of options is displayed.</p>										
DiaLogOnline	<p>Antx’ internet-based service that allows user to view status reports, view event logs, view data logs, receive e-mail notification if the Elite is not working as expected (line always busy, no answer, human answers, etc.).</p> <p>Additionally, most Elites can be programmed from the Internet using this services.</p>										

---

Digital Input	<p>The Digital Input card can be used to detect voltage transitions in addition to dry contact transitions. The range of voltage for digital inputs is 0-30VDC, meaning that any voltage between 6 and 30 V is detected as a closed condition and anything below 6 VDC is considered open</p> <p>Digital Input cards are available with 8 channels per card.</p> <p>The channels are numbered exactly like analog or relay channels, adding the Slot number to the individual channel on the card.</p> <p>Alarm conditions for Digital Inputs are determined based on the Channel State – Normally Open or Normally Closed. When the input transitions out of the Normal condition, the channel goes into alarm.</p> <p>When the channel goes into alarm, relays can be activated or deactivated and alarm call-outs can be performed.</p>
<hr/>	
Disabled	Channel is not scanned or evaluated for alarms. Channel LED is not lighted.
<hr/>	
Disarm	DISARMed mode is signified by a red blinking RUN LED. In this mode the Elite is monitoring all inputs but will NOT perform any alarm operations including turning on/off relays or performing alarm call outs.
<hr/>	
Disarm to Arm Delay	<p>The Elite automatically returns to the Armed mode after this length of time.</p> <p>[1-1440 minutes] (default is 60 minutes)</p>
<hr/>	
Dry Contact	Digital input connections to the Elite are typically dry contacts, meaning that the device or switch that is connected to the Elite is not supplying any voltage or current.
<hr/>	
Duration Limit	<p>The Duration is typically used to provide a Run-Time meter. If a Duration Limit is specified, then alarms calls or relay activation occurs when the Duration value meets the Duration Limit. For example, if you wanted to know when a motor had run 100 hours, then you would specify the Duration Limit to be 100 hours or 360,000 seconds.</p> <p>The duration counter is the total time that an input has been in the non-normal condition from the last time that it was reset. The alarm associated with the duration is the Duration Limit, which is specified in seconds from 0 (disabled) to 999,999,999.</p> <p>Whenever the channel goes to the non-normal state, the duration counter is incremented for every second that it is in the non-normal state. When the duration counter reaches the Duration Limit value, an alarm is generated. The duration counter continues to be incremented until it is reset. It is reset automatically when the Limit Reset Period expires.</p>

---

---

Engineering Units	0 – none	12 – million gph	24 - kilowatts
	1 – milliamps	13 – liters per hour	25 - degrees
	2 – amps	14 – cubic inches / second	26 – psi
	3 – volts	15 – cubic feet / minute	27 – percent
	4 – degrees C	16 – cubic feet / hour	28 – pH
	5 – degrees F	17 – pounds / hour	29 – Hz
	6 – gallons	18 – feet per second	30 – kHz
	7 – liters	19 - inches	31 – million gal
	8 – pounds	20 - feet	32 - ppb
	9 – kilograms	21 -meters	33 - %vol
	10 – gallons per minute (*)	22 - ppm	34 - %lel
11 – gallons per hour (*)	23 - watts		

(\*) If selected then the Elite will automatically compute the total flow.

---

Enter (#) key	Enter the current entry
	Backup one level in the menu

---

Event Log

The event log stores the 1000 most recent events that have occurred in the Elite. The information that is stored is alarm conditions, call-outs, and call-ins. All events are logged with the following information:

- <Date and Time> <Event logged information>

<b>Event Type</b>	<b>Event logged</b>
<b><i>System Alarms</i></b>	
Primary Power	Primary power returned to normal Primary power failure Alarm acknowledged
Battery Power	Battery power low Battery power returned to normal Alarm acknowledged
Phone Fault	No dial-tone detected
<b><i>Digital Input Channel Alarm</i></b>	
Mode = Status Only	ON OFF
Mode = Call on Alarm	Alarm delay timeout Return to normal Alarm acknowledged
Mode = Call on Limit	Totalizer alarm  Totalizer alarm cleared Duration alarm cleared Duration alarm Alarm acknowledged
<b><i>Analog Input Channel Alarms</i></b>	
Mode = Call on Alarm	Low limit alarm Low limit alarm cleared High limit alarm High limit alarm cleared Positive rate of change alarm Negative rate of change alarm Positive rate of change alarm cleared Negative rate of change alarm cleared Alarm acknowledged
<b><i>Relay Output Channels</i></b>	
	Relay energized Relay de-energized
<b><i>Call-outs</i></b>	
	Number '#' answered Number '#' busy Number '#' no answer
<b><i>Call-ins</i></b>	
	Caller_ID

Firmware Version

Displays the version of the code running in the Elite.

Full Scale

The full scale engineering unit value for an analog channel.  
For example, on a 4-20ma signal, the engineering unit value at 20ma.

Global option	<p>The Global option provides a quick method to set all entries to a specific value. The Global option can be used to set Channel parameters, Phone parameters, and Telephone List Schedule parameters.</p> <p>The Global option works for an individual parameter at a time.</p> <p>To enable the Global option, you enter <input type="text" value="*"/> <input type="text" value="4"/> prior to entering your new parameter value. When global is enabled you hear “Global Enabled”. After you enter your new parameter setting you hear “Global Disabled”.</p>		
Green LED	Indicates the channel is in the Normal condition and is enabled.		
Headphone Connection	<p>The Elite is built with a headphone (external speaker) connector that is attached to the main board and is visible when the internal door holding the electronics is opened. This 3-position connector provides an attenuated signal and a maximum volume signal. (Page 14)</p> <p>If you need further amplification, you may connect to an amplifier.</p>		
HI	Shown on the display and in reports. Indicates the channel has a High alarm.		
High Limit	A 5-digit value that defines the high alarm limit for a channel in engineering units. For example, 00200 would be 20.0 if the Decimal Position is 1.		
Holiday Calendar List	<p>List of up to 20 holidays specified by Month and Day.  Month is 1 – January through 12 – December, 13 – January next year  Day is the day of the Month</p> <p>Holidays are special days that can be used for different alarm notification phone lists or status notification lists.</p> <p>To delete a holiday that has been entered, you can either re-enter the same month/day, Press * 2 or press the <input type="button" value="Arm"/> <input type="button" value="Reset"/> button.</p> <p>There are a total of 13 months allowed. January of the current year (01) through December of the current year (12) plus January of the next year (13). This allows you to setup the days in next January ahead of time so that no one needs to reprogram these days during the New Years holiday period.</p> <p>You can only enter months/days that have NOT already passed on the calendar. i.e. if today is June 5, then you cannot enter any day prior to June 5.</p> <p>There are no default holidays.</p>		
HOME key	Go to the top of the Programming Menu		
Input type	0 – 0 to 1 V 1 – 0 to 5 V	2 – 1 to 5 V 3 – 0 to 10V	4 – 0 to 20ma 5 – 4 to 20ma
IO Register Type	See Register Type		
Limit Reset Period	Specifies the amount of time in minutes from the start of the day, that the duration counter is incremented and totalizer is accumulated until it is automatically reset.		

Listen In	<p>At a remote telephone, the Listen In selection lets you hear sounds picked up by Elite's internal microphone, such as the noise of a pump motor. To activate the Listen In function, press the <b>5</b> key on your phone when in RUN mode.</p> <p>Press <b>5</b> to Listen In at any time during a call. The command turns on the microphone, and <i>Listen In</i> remains in effect for 2 minutes.</p> <p>Press any key during the 2-minute time to exit.</p>
LO	Shown on the display and in reports. Indicates the channel has a Low alarm.
Low Battery	See Battery Channel
Low Limit	A 5-digit value that defines the low alarm limit for a channel in engineering units. For example, 00200 would be 20.0 if the Decimal Position is 1.
Max Idle	The maximum amount of time the Elite waits for another character to be received after the last one was received.
Max Timeout	The maximum amount of time the Elite waits for a response when it transmits a message.
Maximum Counts	The maximum number of counts read from a Modbus Holding Register. This is only used if the value in the Holding Register is in counts and needs to be scaled.
Message Repeat	Number of times to repeat the alarm message during an alarm call out. [1-20] (default is 2)
Minimum Counts	The minimum number of counts read from a Modbus Holding Register. This is only used if the value in the Holding Register is in counts and needs to be scaled.
Modbus ID	A value between 1 and 247 to uniquely identify each Slave device.
Modbus Master	<p>The Elite can act as a Modbus Master through the serial RS-232/RS-485 ports 2 or 3. Set the Port Mode to 3, for Master.</p> <p>When this option is enabled, the Elite acts as a Modbus Master to read/write registers from one or more Modbus Slave devices.</p> <p>To define channels, a slot (1-9) must be enabled to be a Modbus Slot. This is performed through Options Setup selection 3 (MODBUS Master Setup). Enable one or more slots (cannot contain physical cards).</p> <p>For each slot enabled, 8 channels are available to be inputs or outputs.</p> <p>For example, if Slot 7 was enabled, then channels 71 to 78 would be available for use.</p>
Modbus Slave	<p>The Elite can act as a Modbus Slave through the serial ports 2 or 3 or the phone connection. This option must be enabled.</p> <p>All current values in the Elite can be read from a Modbus Master.</p> <p>This option is configured in the Option Setup for ports 2 or 3.</p> <p>Set the Mode = 2 (Slave), Baud rate and Maximum Idle Time.</p>



Modbus Slot	As a Modbus Master, the Elite reads/writes to logical channels. These channels are associated with slots, just like physical I/O. A slot enabled for Modbus allows 8 channels to be used for reading or writing to a Modbus Slave device. Channels are numbered just like physical channels. For example, Slot 50 would be channels 51 to 58.												
Modem call	<p>Modem calls are made using the internal modem of the Elite. The Elite can transmit 2 types of reports directly to a modem,</p> <ol style="list-style-type: none"> <li>1. an ASCII formatted Status Report and,</li> <li>2. a comma-separated value, CSV, report that contains the same information as a Status Report, but with each field separated by a comma</li> </ol> <p>To call-out to a modem, put the Modem code ( * 0 2 ) at the end of the phone number for an ASCII report.</p> <p>To call-out to a modem, put the Modem code ( * 0 3 ) at the end of the phone number for a CSV report.</p> <p>A telephone list entry for a modem phone number includes the: (modem number) (* 0x)</p>												
Modem Setup	<p>Setup parameters for the modem.</p> <table border="1"> <thead> <tr> <th>Parameter</th> <th>Range</th> <th>Default</th> </tr> </thead> <tbody> <tr> <td>Max Idle</td> <td>1-32000 milliseconds</td> <td>850</td> </tr> <tr> <td>Max Timeout</td> <td>1000-32000 milliseconds</td> <td>8000</td> </tr> <tr> <td>ID (Modbus)</td> <td>1-247</td> <td>126</td> </tr> </tbody> </table> <p>Max Idle – maximum amount of time the Elite waits for another character to be received after the last one was received.</p> <p>Max Timeout – maximum amount of time the Elite waits for a response when it transmits a message</p> <p>ID – Modbus Slave ID of the Elite when it is called from a Modbus Master over a modem connection</p>	Parameter	Range	Default	Max Idle	1-32000 milliseconds	850	Max Timeout	1000-32000 milliseconds	8000	ID (Modbus)	1-247	126
Parameter	Range	Default											
Max Idle	1-32000 milliseconds	850											
Max Timeout	1000-32000 milliseconds	8000											
ID (Modbus)	1-247	126											
Negative Rate of Change	If the analog reading falls at a rate that exceeds the Negative Rate of Change within the time specified by the Rate of Change Period, then the channel goes into alarm.												
Next Call Delay	The amount of time to wait after completing this call until the next phone number is dialed. [0-3600 seconds] (default is 30 seconds)												
Normally Open/Closed	Used on Digital Inputs to set the Normal, or not in alarm, condition of the input. When the input changes from this normal condition, the channel goes into the alarm state.												
Notify Once	If enabled (1), when this call is successfully made, it is not called again for this alarm condition, until the Redial After Acknowledge timer has expired.												
Numeric ID	Numeric value that shows up on Pagers when an alarm call is made to a pager. Field is 16 digits long.												

---

**Open Loop Limit** For all Analog Input channels that are 0-20ma or 4-20ma.  
Defines a limit that if the input falls below the Elite will assume the input is an Open Loop. When an Open Loop condition exists, channel 07 (System Fault) goes into alarm.

---

**Options Menu** See Options Setup

---

**Options Setup** This Menu has 8 selections to set the various Options that can be purchased with the Elite.

<b>Option Number</b>	<b>Description</b>
0	Port 1 UART Setup (only available with GSM cellphone)
1	Port 2 Setup
2	Port 3 Setup
3	Modem Setup
4	Modbus Master Setup
5	Open Loop Limit Analog Input Scaling Factor Analog Input Offset Factor
6	Acknowledge Input Channel
7	Pump Control (separate product manual)

---

**Pager call** To call-out to a pager, put the Pager code (\*7) at any position in the phone number. The Elite calls the number and when answered delivers the System Identification number followed by the number(s) of the channel(s) in alarm. This message is delivered using DTMF, or Touch-Tone, tones instead of a voice message.

If Channel 17 were in alarm, the message on the pager would be: 4337676-17

If Channels 17, 18 and 34 were in alarm, the message on the pager would be: 4337676-17-18-34.

The numbers are sent just once (the Message Repeat parameter is not applicable).

---

**Phone Channel** Channel 03 – monitors the phone line automatically every 2 hours for a dial-tone. If no dialtone is detected, the Phone Fault light is turned red and a relay may be activated.

Automatic dial-tone checking can be eliminated by setting the Channel Mode to Disabled (0).

---

**Phone Check** While in RUN Mode, the Elite automatically checks to see if a dialtone exists every 2 hours. If it does exist, then the Elite returns to RUN Mode

If there is no dial-tone, then the Phone channel (03) goes into alarm and the Phone LED is lit Red.

The Phone channel can be disabled by setting the Channel Mode to Disabled (0)  
To manually perform a Phone Check, press the Phone key (4) while in RUN Mode.

---

Phone fault	Displayed on the RUN Mode display and the Alarm Screen when the Elite has detected a no-dialtone condition on the phone line. The Elite automatically checks for a dialtone every 2 hours if the Phone channel (03) Channel Mode is Status Only. If the Channel Mode is Disabled, the dialtone check is not performed.						
Phone List Number	<p>A number between 1 and 16 to identify a specific list of phone numbers are to be used for alarm calls.</p> <p>Phone List 1 is the highest priority, meaning that if channels are in alarm and some use Phone List 1 and some other Phone Lists, then Phone List 1 is satisfied before any of the other Phone List calls.</p> <p>By default, each input uses Phone List 1.</p>						
Phone List Position	A number between 1 and 16 within a specific Phone List. These phone numbers are called in order from 1 through 16 until the alarm condition no longer exists or the alarm is acknowledged.						
Phone Setup	Menu selection to enter or modify phone numbers to be called when alarm conditions exist.						
Port Mode	<p>For serial ports 2 and 3 the Mode defines how the port is going to be used.</p> <table> <tr> <td>0 – not used</td> <td>3 – Modbus Master</td> </tr> <tr> <td>1 – debug or diagnostics</td> <td>4 – Web (DiaLogOnline)</td> </tr> <tr> <td>2 – Modbus Slave</td> <td></td> </tr> </table>	0 – not used	3 – Modbus Master	1 – debug or diagnostics	4 – Web (DiaLogOnline)	2 – Modbus Slave	
0 – not used	3 – Modbus Master						
1 – debug or diagnostics	4 – Web (DiaLogOnline)						
2 – Modbus Slave							
Ports	<p>The available ports in the Elite are:</p> <table> <tr> <td>0 – UART used for GSM cell phone</td> <td>2 – Port 3</td> </tr> <tr> <td>1 – Port 2</td> <td>3 - Modem</td> </tr> </table>	0 – UART used for GSM cell phone	2 – Port 3	1 – Port 2	3 - Modem		
0 – UART used for GSM cell phone	2 – Port 3						
1 – Port 2	3 - Modem						
Positive Rate of Change	<p>If the analog reading rises at a rate that exceeds the Positive Rate of Change within the time specified by the Rate of Change Period, then the channel goes into alarm.</p> <p>For example, if the Positive Rate of Change is set to 100.00 and the Rate of Change Period is set to 15 minutes, then if the analog reading exceeds 100.00 in less than 15 minutes the channel goes into alarm.</p>						
Power Fail	See Primary Power Channel						
Press any key to continue	When making a call to the Elite, the Elite goes through a simple process to verify that you are a person and not a computer. If you press a key on your phone during the initial 5 second period after hearing “Press any key to continue”, the Elite assume you are a person and speaks the Status of the Elite.						
Primary List Start Time	Enter a starting hour and minute that the Primary Phone List is to be used.						

Primary Phone List	<p>There are 2 types of phone lists in the Elite, Primary and Secondary. The purpose of the 2 lists is to provide a way to have different phone numbers called at different times of day.</p> <p>If you are going to call the same phone numbers 24/7, then you only need to put phone numbers into the Primary List.</p> <p>16 lists of phone numbers that are used for alarm calls after the Primary List Start Time has passed.</p> <p>If no Primary or Secondary List Start Times have been specified, this Primary Phone List is always used for alarm calls.</p>
Primary Power Channel	<p>Channel 01 – monitors the primary power to the main processor board. This power is typically 24VDC. Low and High alarm limits can be specified for alarm relay activation or call outs. The Primary Power LED indicates if the battery is fully charged (green), being charged (green blinking), or in alarm (red and red blinking).</p>
PROGRAM Mode	<p>In this mode the user can make modifications to any and all settings.</p> <p><b>NOTE:</b> RUN mode must be entered after making programming changes for those changes to be saved permanently.</p> <p><b>NOTE:</b> While in PROGRAM Mode, relays are activated when conditions warrant, but alarm calls are not made.</p>
Program to Run Delay	<p>The Elite automatically returns to the Run mode after this length of time. [1-1440 minutes] (default is 60 minutes)</p>
Pulse Counting	<p>The Digital Input card can be used to count pulses, or the number of times that the input signal goes into the On, or non-normal, state. The maximum frequency that can be counted is 2 Hz with a required duty cycle of 50%. This means that the signal coming into the Elite must be active (high or low) for 250msec in order for it to be counted as a pulse.</p> <p>When counting pulses, you program the Totalizer Count Limit under the Channel Configuration for the specific channel being monitored. The Elite counts all of the pulses that occur, incrementing the Totalizer value for each pulse. When the Totalizer Count Limit is reached, an alarm condition exists and the Totalizer continues to count pulses until it is reset, either upon acknowledgement or when the Limit Reset Period is reached.</p> <p>The Elite reports the value of the Totalizer Count either in the default value of counts, or in Engineering Units. In both cases, you can also specify a Scaling Value to multiply each count by.</p> <p>An example of using a Scaling Value is to total the flow through a pipe over a given time, where each pulse represents a specific amount of volume. For example, you could set the Scaling Value to 100 to indicate 100 gallons per pulse.</p>
Pulse Duration	<p>An amount of time that a relay stays energized. [0 – 86400 seconds] (default is 0)</p> <p>0 keeps the relay on until another action turns the relay off</p> <p>Another condition can override this and de-energize the relay.</p>
Rate of Change	<p>Positive or Negative. Specifies an alarm limit based on the rate the sensor input is changing. Specified as a value over the Rate of Change Period. The maximum period of time is 60 minutes.</p>

Rate of Change Period	<p>Specified as 1 to 60 minutes. This is the amount of time that the channel value must change by the Positive or Negative Rate of Change to go into the alarm condition.</p> <p>For example, to go into alarm if a tank level drops more than 1000 gallons in a 15 minute period, set the Rate of Change Period to 15 minutes and the Negative Rate of Change to 1000.</p>																																	
Read Packed Bits	See Bits.																																	
Red LED	Indicates the channel has a High alarm. If blinking, the alarm is not acknowledged. If solid, the alarm is acknowledged.																																	
Redial after Ack Delay	When alarms are acknowledged, the Elite automatically starts the alarm call out sequence after this delay if the current alarm conditions still exist. If other alarms occur before this delay expires, alarm calls are performed immediately.																																	
Register Number	<p>A valid Modbus register number from 1 to 9999.</p> <p>Some PLCs refer to registers as a combination of the Register Type and the Register Number. For example, a PLC may reference register 40100. In the Elite, this would be a Read Holding and Register Number 100.</p> <p>To read a channel from the same Elite, the register number is based on the channel number in the Elite:</p> <table border="1" data-bbox="526 894 1336 1354"> <thead> <tr> <th></th> <th>Elite Channel #</th> <th>Register Number</th> </tr> </thead> <tbody> <tr> <td>System Channels</td> <td>01 - 08</td> <td>1 - 8</td> </tr> <tr> <td>Slot 10</td> <td>11 - 18</td> <td>9 - 16</td> </tr> <tr> <td>Slot 20</td> <td>21 - 28</td> <td>17 - 24</td> </tr> <tr> <td>Slot 30</td> <td>31 - 38</td> <td>25 - 32</td> </tr> <tr> <td>Slot 40</td> <td>41 - 48</td> <td>33 - 40</td> </tr> <tr> <td>Slot 50</td> <td>51 - 58</td> <td>41 - 48</td> </tr> <tr> <td>Slot 60</td> <td>61 - 68</td> <td>49 - 56</td> </tr> <tr> <td>Slot 70</td> <td>71 - 78</td> <td>57 - 64</td> </tr> <tr> <td>Slot 80</td> <td>81 - 88</td> <td>65 - 72</td> </tr> <tr> <td>Slot 90</td> <td>91 - 98</td> <td>73 - 80</td> </tr> </tbody> </table>		Elite Channel #	Register Number	System Channels	01 - 08	1 - 8	Slot 10	11 - 18	9 - 16	Slot 20	21 - 28	17 - 24	Slot 30	31 - 38	25 - 32	Slot 40	41 - 48	33 - 40	Slot 50	51 - 58	41 - 48	Slot 60	61 - 68	49 - 56	Slot 70	71 - 78	57 - 64	Slot 80	81 - 88	65 - 72	Slot 90	91 - 98	73 - 80
	Elite Channel #	Register Number																																
System Channels	01 - 08	1 - 8																																
Slot 10	11 - 18	9 - 16																																
Slot 20	21 - 28	17 - 24																																
Slot 30	31 - 38	25 - 32																																
Slot 40	41 - 48	33 - 40																																
Slot 50	51 - 58	41 - 48																																
Slot 60	61 - 68	49 - 56																																
Slot 70	71 - 78	57 - 64																																
Slot 80	81 - 88	65 - 72																																
Slot 90	91 - 98	73 - 80																																
Register Type	<p>Modbus register type of the Slave Modbus device being read.</p> <p>Valid values are:</p> <table data-bbox="537 1514 1308 1650"> <tr> <td>1 – Read Coil</td> <td>4 – Read Input Register</td> </tr> <tr> <td>2 – Read Input Type</td> <td>5 – Write Coil</td> </tr> <tr> <td>3 – Read Holding Register</td> <td>6 – Write Holding</td> </tr> <tr> <td></td> <td>7 – Read Packed Bits (from Holding Register)</td> </tr> </table>	1 – Read Coil	4 – Read Input Register	2 – Read Input Type	5 – Write Coil	3 – Read Holding Register	6 – Write Holding		7 – Read Packed Bits (from Holding Register)																									
1 – Read Coil	4 – Read Input Register																																	
2 – Read Input Type	5 – Write Coil																																	
3 – Read Holding Register	6 – Write Holding																																	
	7 – Read Packed Bits (from Holding Register)																																	
Relay channel	<p>If configuring an input, this is the physical relay or relay list that is to be activated.</p> <p>Physical relays are numbered 11-14, 21-24 . . . 61-64</p> <p>To control a relay on a remote device, enter 99. The specific relay to control is entered in the phone number of the Telephone List specified for this channel.</p> <p>See Remote Relay Control for more details.</p>																																	

---

Relay list

A list of up to 9 physical relays that can be controlled when any input changes from the Normal to Non-Normal condition or from the Non-Normal back to the Normal condition. A relay list consists of:

Relay List Number	
Position	Physical Relay #
1	
2	
3	
4	
5	
6	
7	
8	
9	

Each physical relay is pre-configured to be the first relay in the List Number that matches the Physical Relay number. So, if you only need to control a single relay, you do not need to create a Relay List, it is already configured. For example,

If a Relay Card is in Slot 20		
Relay List Number	Position	Physical Relay #
21	1	21
22	1	22
23	1	23
24	1	24

---

Relay state from High Alarm

Specify if the relay will de-energize(0), energize(1) or no change (2-disabled), when the input transitions from the High Alarm.

---

Relay state from Low Alarm

Specify if the relay will de-energize(0), energize(1) or no change (2-disabled), when the input transitions from the Low Alarm to the Normal state.

---

Relay state to High Alarm

Specify if the relay will de-energize(0), energize(1) or no change (2-disabled), when the input transitions to the High Alarm.

---

Relay state to Low Alarm

Specify if the relay will de-energize(0), energize(1) or no change (2-disabled), when the input transitions to the Low Alarm.

---

Remote Relay Control	<p>The Elite can control relays on remote Modbus RTU Slave devices, typically another Elite.</p> <p>Remote relays are controlled based on the condition of the input channel being monitored. For each input channel you can specify a remote relay that you want to control. Multiple input channels can control a single relay or independent relays.</p> <p>To specify a remote relay, you enter the value 99 in the Relay channel to activate field on any System, Digital or Analog Input channel. In the Telephone Number you specify the phone number of the remote DiaLog Elite, the relay number, the Modbus ID and whether the local alarm should be acknowledged when the remote relay is energized or de-energized.</p> <p>The format for specifying which relay to control at a remote site is:  <i>(phone number) *01 (Modbus ID) (remote relay number) (auto-acknowledge)</i></p>
Remote Scan Rate	<p>The rate the Elite scans a remote (via modem dial-out) Slave device.</p> <p>To configure the Elite to scan a remote Slave device, create a Modbus channel for the appropriate Slave ID, Register Type and Register Number. Set the Phone List to 16. Configure Phone List 16, Position 1 to be the phone number of the remote Slave modem.</p>
Repeat Interval	<p>Number of minutes until this action is performed again.  [0-1440 minutes] (default is 1440 minutes) 0 is never</p>
Reset Counters	<p>Selection 7 under System setup.</p> <p>Allows the user to reset one or all counters for a channel.</p>
Reset key	<p>Reset this entry to the factory default.</p>
Reset to System Defaults	<p>Performing this function erases all user programming and sets the system back to the factory settings.</p> <p><b>NOTE:</b> This is only written to permanent memory when the Elite is put into RUN mode. If you do not want to reset the system, turn the Elite off <i>before</i> returning to RUN mode.</p> <p>Hidden underneath this function is a method to Backup and Restore a complete programmed configuration. Enter '9' then the access code (*42552) to enable this function.</p>
Restore	<p>See Reset to System Defaults</p>
Ring Count	<p>Specifies the number of phone rings before the Elite answer the call.</p>
RS-485	<p>Port 2 or 3 can be used as either a RS-232 or RS-485 connection. If RS-485 is enabled, then the 6-position connector on the top-back of the large processor board (location J17) is used for communication.</p> <p><b>NOTE:</b> Do not connect to both the RS-232 and the RS-485.</p>
RS485 Off Delay	<p>Specifies in milliseconds that amount of time the Elite waits after sending the last character of a transmission until it turns off the RS485 transceiver (goes to tri-state condition)</p>

RS485 On Delay	Specifies in milliseconds that amount of time the Elite waits after turning the RS485 transceiver on before it transmits the first character of a transmission.
RUN Mode	In this mode the Elite is monitoring all inputs and performing all alarm functions.  <b>NOTE:</b> This mode must be entered after making programming changes for those changes to be saved permanently.
Scale Input	This allows for scaling or adjusting the signal reading to match the sensor settings. Example 1: Sensor is 4-20ma with a range of 0 to 100.0 Decimal Position = 1 Zero (4ma reading) = 0 Full Scale (20ma reading) = 1000 (with 1 digit to the right of the decimal)  Example 2: Input is Modbus Holding Register with 16-bits, range is 0 to 65535. The value needs to be scaled to 400 to 20000 Decimal Position = 0 Zero = 400 Full Scale = 20000 Minimum Counts = 0 Maximum Counts = 65535
Scaling Value	This value is multiplied by the number of counts to compute the value that is compared to the Totalizer Limit.  This is typically used for counters, where each count represents a larger increment. For example, 1 count may represent 100 gallons, so the Scaling Value would be set to 100.
Scan Rate	The Elite reads all Modbus Slave devices every 'scan rate' seconds.
Scrl	Pressing the SCRL key rotates the display through all enabled channels.
Secondary List Start Time	Enter a starting hour and minute that the Secondary Phone List is to be used.
Secondary Phone List	There are 2 types of phone lists in the Elite, Primary and Secondary. The purpose of the 2 lists is to provide a way to have different phone numbers called at different times of day.  If you are going to call the same phone numbers 24/7, then you only need to put phone numbers into the Primary List. If you are going to call different phone numbers based on time of day, then some numbers will go in the Primary list and the others in the Secondary list.  See the Telephone List Schedule page 86 for details on how the Elite switches from the Primary List to the Secondary List.  16 lists of phone numbers that are used for alarm calls after the Secondary List Start Time has passed.  If no Secondary List Start Times have been specified, the Primary Phone List is always used for alarm calls.



Serial Port	<p>The Elite has 3 serial ports, Port 1, 2 and 3. Port 1 is reserved for GSM cellular phone usage. Ports 2 and 3 are on DB9 connectors if using RS-232 or a 6-pin connector is using RS-485</p> <p>The RS-232 port is a 9-pin connector located on the back of the large processor board. It can be used to communicate with Modbus Slave or Master devices either via direct connection or using radio modems.</p> <p>Any of the ports can be used to program and print reports from the Elite when they are enabled as a Diagnostics port. (Port Mode = 1)</p>				
Sign	To switch between (+) and (-) when setting numeric values, press the '*' key twice.				
Slave ID	<p>Modbus ID number of the Slave device. Modbus uses a Master to initiate communication to a number of Slaves.</p> <p>The default Slave ID of the Elite is 126, but can be modified in the Options Setup when defining a specific port to be a Slave (Port Mode = 2)</p> <p><b>NOTE:</b> If the Slave ID is 0, then an analog channel in the Elite is being read.</p>				
Slot Number	<p>I/O in the Elite are referenced by Slot Number. Each slot contains up to 8 channels.</p> <p>Physical slots are numbered 1 through 6. Modbus slots are numbered 1 through 9.</p>				
Speaker Volume	Adjusts the volume of the local speaker from 0 – Off to 255 – High				
Speakerphone	<p>This selection allows you to use the Elite as a hands-free speakerphone. At the prompt enter a phone number, including [*] 9 for delay, [*] [*] for star, [*] # for pound. The phone number is dialed when the ENTER key is pressed.</p> <p>To end the speakerphone session, press the  key.</p> <p>The person on the Elite end of the call can adjust the speaker volume and microphone sensitivity to their preference. These are adjusted with the following settings:</p> <table data-bbox="540 1318 1243 1388"> <tr> <td><b>F1</b> Increase microphone sensitivity</td> <td><b>F3</b> Increase speaker volume</td> </tr> <tr> <td><b>F2</b> Decrease microphone sensitivity</td> <td><b>F4</b> Decrease speaker volume</td> </tr> </table>	<b>F1</b> Increase microphone sensitivity	<b>F3</b> Increase speaker volume	<b>F2</b> Decrease microphone sensitivity	<b>F4</b> Decrease speaker volume
<b>F1</b> Increase microphone sensitivity	<b>F3</b> Increase speaker volume				
<b>F2</b> Decrease microphone sensitivity	<b>F4</b> Decrease speaker volume				
Start Time	<p>Enter a start hour and minute.</p> <p>The Start Hour must be in 24-hour format.</p>				
Status Notification Schedule	<p>The Elite can be programmed to make scheduled call-outs periodically through out the day, 7 days a week plus holiday. Calls are made starting at the time specified by the start hour and start minute and repeated every repeat interval minutes.</p> <p>A Status Notification Schedule can be set up to deliver a Status Report at any time during the day or week or a repeated time interval, like every 4 hours.</p> <p>Or via modem by entering a modem number into the specified telephone list followed by the special keys [*] 0 2</p>				

---

Status Only

Analog and digital channel is scanned but not evaluated for alarms. Relay channel is active. Generally used to view values on the display or when values are passed to a Modbus Master and not for call out.

---

Status Report

The Status Report is a formatted list of all channels in an Elite, including System, Digital, Analog, Relay and Modbus channels.

The Status Report can be automatically sent to a modem or automatically read by the Internet using DiaLogOnline.

The Status Report can be reported on-demand by dialing into the Elite from a PC or directly connecting to the Elite via a PC.

An example report is shown below:

---

3/01/05 09:45

DIALOG ELITE 12345678901234567890

\*\* STATUS Report \*\*

```
S01 Primary Supply          15.1 volts
S02 Battery Supply         13.2 volts
S03 Phone                   0.0
S04 Temperature            27.8 degC
S05 Aux Supply              24.1 volts

D21 Access Door            Al Ak      Op
D22 Pump 1 Run Time        122 cnts  0 01:07:14
D23 Pump 1 Overheat        Op
D24 Chan 24                 Op

A31 Pump 1 Flow Rate        255 gpm   .223 mgal
A32 Tank 1 Level            230.00 feet
A33 Reservoir Temp          Al   Lo    33.98 degF
A34 Chan 34                 Dis
A35 Chan 35                 Dis
A36 Chan 36                 Dis
A37 Chan 37                 Dis
A38 Chan 38                 Dis

R51 Pump 1                  Op
R52 Pump 2                  Op
R53 Remote Pump 1          Op
R54 Remote Pump 2          Op
```

---

Key for the Status Codes:

Ak – Acknowledged alarm	DL – Digital Duration Limit alarm
Al – In alarm	Lo – Analog Low limit alarm
Dis – Channel is disabled	Hi – Analog High limit alarm
Op – Digital input channel is Open	+R – Analog Positive Rate of Change alarm
Cl – Digital input channel is Closed	-R – Analog Negative Rate of Change alarm
Cm – Communication alarm (Modbus)	
TL – Digital Totalizer Limit alarm	

---

System Delays	<p>There are 2 System Delays:</p> <p><b>Program to Run Mode Delay</b> Specify the amount of time that must elapse before the DiaLog Elite automatically goes from PROGramming mode to Run mode if the system is inadvertently left in the PROGramming mode.</p> <p><b>Disarm to Arm Delay</b> Specify the amount of time that must elapse before the system goes from Disarm to Arm status.</p>						
System Fault Channel	<p>Channel 07 – provides a single fault if any enabled analog input channel falls below a pre-defined low limit. This is used to detect open loops generally.</p> <p>A value must be specified for the Open Loop Limit in the Options&gt;Analog Input section.</p>						
System Identification	<p>There are 3 parts to the System Identification</p> <table border="0" data-bbox="539 730 1289 961"> <tr> <td data-bbox="539 730 656 758">Voice ID</td> <td data-bbox="764 730 1243 814">A 6-second user-recorded message that is spoken through the speaker or vial call-out to identify the specific Elite.</td> </tr> <tr> <td data-bbox="539 831 656 858">Numeric ID</td> <td data-bbox="764 831 1289 884">A 20 digit value that is automatically sent to pagers on alarms.</td> </tr> <tr> <td data-bbox="539 900 711 928">Alphanumeric ID</td> <td data-bbox="764 900 1243 953">A 20 character name that is shown on reports and alphanumeric pagers to identify the specific Elite.</td> </tr> </table>	Voice ID	A 6-second user-recorded message that is spoken through the speaker or vial call-out to identify the specific Elite.	Numeric ID	A 20 digit value that is automatically sent to pagers on alarms.	Alphanumeric ID	A 20 character name that is shown on reports and alphanumeric pagers to identify the specific Elite.
Voice ID	A 6-second user-recorded message that is spoken through the speaker or vial call-out to identify the specific Elite.						
Numeric ID	A 20 digit value that is automatically sent to pagers on alarms.						
Alphanumeric ID	A 20 character name that is shown on reports and alphanumeric pagers to identify the specific Elite.						
Telephone List	<p>The Elite supports a total of 16 phone lists arranged in a priority fashion. Phone List 1 is the highest priority, 2 is second and so on.</p> <p>Each input channel references a Telephone List to call when it goes into alarm. If more than one channel is in alarm at the same time, then the channels which use the highest priority Telephone List are called first and must be acknowledged before the next highest priority Telephone List is called.</p> <p>If a Telephone List has no phone numbers, then no calls are made. Enter a list number between 1 and 16.</p> <p>To call a phone or cell phone, simply enter the phone number into the List Position desired. The phone number can include delays, waiting for a dial-tone and any key that can be pressed on a telephone keypad. Each phone number can be up to 50 numbers/characters in length. You can program up to 512 telephone numbers using all 16 lists of 16 numbers and both the Primary and Secondary lists.</p> <p>Each telephone number can have up to 50 digits, including special characters.</p> <p>For each telephone number, you can also program Call Delay, Notify Once and Call Progress settings.</p>						

---

Telephone List Schedule

Provides method to notify different phone numbers based on the time of day and day of week. Separate start hours/minutes can be specified for each day and a set of holidays.

For example,

If your facility is manned during the normal working hours (7:30am – 4:30pm) Monday-Friday and has people on call all other hours, you could configure the Elite as follows:

Day	Day of the Week	Primary Start Time	Secondary Start Time
1	Sunday	00:00	Disabled
2	Monday	16:30	07:30
3	Tuesday	16:30	07:30
4	Wednesday	16:30	07:30
5	Thursday	16:30	07:30
6	Friday	16:30	07:30
7	Saturday	00:00	Disabled
8	Holiday	00:00	Disabled

Since Saturday, Sunday and Holiday are disabled, then the last time that was specified on the previous day is still valid. In the case above, the last time specified on Friday was 16:30 for the Primary Start Time. Therefore, the Primary List is active from 16:30 on Friday until the next time the Secondary List is active, which is 07:30 on Monday morning.

In the case of the Holiday, which usually occurs on Mondays, the Primary List would stay active until the Secondary List was activated, probably at 07:30 on Tuesday morning.

---

Telephone Number

A 50-digit number to call upon alarm. The following special key sequences can be added to a phone number.

**NOTE:** Only press the '\*' once. For example, pressing '\*3' will display an 'F'.

- |    |                          |    |                             |
|----|--------------------------|----|-----------------------------|
| *2 | Deletes the phone number | *5 | Call alphanumeric pager (A) |
|    |                          | *8 | Detect dialtone (W)         |
| *7 | Call a numeric pager (P) | ** | * tone                      |
| *9 | 2 second delay (,)       | *# | # tone                      |

---

Temperature Channel

Channel 04 – monitors the temperature inside the Elite enclosure. Low and High alarm limits can be specified for alarm relay activation or call outs or disabled.

---

Text Messages	<p>The Elite can deliver text messages by calling a cellular access number that uses the TAP protocol and sending a message in the same format as an Alphanumeric pager.</p> <p>All versions of the Elite can support sending alarm and/or status messages to cell phones that have text messaging enabled.</p> <p>Configure the Elite phone number as follows:          (Access number) A (10-digit cell phone number)</p> <p>The 'A' is entered by pressing the '*' key followed by the '5' key.</p> <p>For a list of the access numbers, see the following web-site:  <a href="http://www.notepage.net/tap-phone-numbers.htm">http://www.notepage.net/tap-phone-numbers.htm</a></p>
Text pager call	See Alphanumeric pager call.
Totalizer Limit	<p>The totalizer is the total number of times that an input has been in the non-normal condition from the last time that it was reset. The alarm associated with the totalizer is the Totalizer Limit, which is specified in counts from 0 (disabled) to 999,999,999.</p> <p>Whenever the channel goes to the non-normal state, the totalizer counter is incremented. When the totalizer reaches the Totalizer Limit value, an alarm is generated. The totalizer continues to be incremented until it is reset. It is reset automatically when the Limit Reset Period expires.</p> <p>For example, you are monitoring a chlorine delivery system that puts out a pulse every time it delivers a predefined amount of chlorine into a stream. You want to be notified anytime more than 500 dispenses are made in any 12-hour period. Specify the Totalizer Limit to be 500 and the Limit Reset Period to be 720 minutes.</p>
Voice ID	This is a user-recorded message that identifies the entire Elite unit. For example, "Station 45 monitoring system"
Write Holding	Allows sending a manually entered analog value to a Modbus Holding register.
Yellow LED	Indicates the channel has a Low alarm. If blinking, the alarm is not acknowledged. If solid, the alarm is acknowledged. (Available on Elite Controllers only)
Zero Scale	<p>The scaling value in engineering units that corresponds to the lowest analog reading. This value can be positive (+) or negative (-). When entering this value, press the '*' key twice toggles between (+) and (-).</p> <p>For example, for a 4-20ma signal that goes from 20.0 to 200.0, the Zero Scale is the value at 4ma. It is entered as 200 with the Decimal Position set to 1.</p>

# Elite – Pocket Reference

## ***How to Set Phone Numbers***

Position 1                    HOME 4 0 01 01 (#)

---

Position x                    HOME 4 0 01 xx (#)

---

## ***How to Set Messages***

System ID                    HOME 3 0 1 (msg)

---

Channel 11                    HOME 9 11 1 1 (msg)

---

Channel xx                    HOME 9 xx 1 1 (msg)

---

## ***How to Set Alarm Delays***

All chans (xx secs)        HOME 9 11 3 \*4 xx #

---

Chan 14 (to 20 secs)      HOME 9 14 3 20 #

---

## ***Taking channel xx in/out of service***

Out of Service                HOME 9 xx 2 1

---

In Service                    HOME 9 xx 2 2

---

## ***How to Set Normally Open/Closed***

Channel 11 (open)          HOME 9 11 0 0

---

Channel 12 (closed)        HOME 9 12 0 1

---

## ***How to Acknowledge Alarms***

Locally                        Press the ACK key

---

Remotely                      Press 9 when asked

---

## ***How to enter Program or Run mode***

Program Mode                HOME 1

---

Run Mode                      HOME 2

---

## ***How to call Customer Service***

From Elite keypad



Via phone                      877-686-2689

---

# Elite Programming Sheets

## System Channels

Primary Power (01), Battery (02), Temperature (04), 24VDC (05)

**Channel mode (2)**  0 – disabled, 1 – status only, 2 – alarm mode 0

Low Limit      00000 – 99999 (assumed decimal position)

High Limit      00000 - 99999

**Alarm delay (3)**    seconds

**Relay List (6)**   01 - 98

Relay state on Normal to Alarm  0 – de-energize, 1 – energize, 2 – no action

Relay state on Alarm to Normal

De-energize on Alarm Ack  0 – do NOT de-energize, 1 – de-energize

Communication (06), System Fault (07)

**Channel mode (2)**  0 – disabled, 1 – status only, 2 – alarm mode 0

**Alarm delay (3)**    seconds

**Relay List (6)**   01 - 98

Relay state on Normal to Alarm  0 – de-energize, 1 – energize, 2 – no action

Relay state on Alarm to Normal  0 – de-energize, 1 – energize, 2 – no action

De-energize on Alarm Ack  0 – do NOT de-energize, 1 – de-energize

# Analog Channels

Channel Number   11 - 98

**Channel Conversion (0)**

Type	<input type="text"/>	0-5
Decimal Position	<input type="text"/>	0 - 9
Engineering Units	<input type="text"/>	0 - 34
Zero Scale (4ma or 0V reading)	<input type="text"/>	+/- 0 - 999,999,999
Full Scale (20ma or 10V reading)	<input type="text"/>	+/- 0 - 999,999,999
Min Counts	<input type="text"/>	0 - 65535
Max Counts	<input type="text"/>	0 - 65535

**Channel Message (1)**

Channel Name	<input type="text"/>
--------------	----------------------

**Channel Mode (2)**

Low Limit	<input type="text"/>	+/- 0 - 999,999,999
High Limit	<input type="text"/>	+/- 0 - 999,999,999
Positive Rate of Change	<input type="text"/>	+/- 0 - 999,999,999
Negative Rate of Change	<input type="text"/>	+/- 0 - 999,999,999
Rate of Change Period	<input type="text"/>	0 - 60 minutes

**Alarm Delay (3)**

**Continue Notify if Normal (4)**  0 - disable, 1 - enable

**Telephone List (5)**

**Low Alarm Relay List (6)**

Relay Low Alarm State	<input type="text"/>	0 - de-energize, 1 - energize, 2 - no action
Relay Low to Normal State	<input type="text"/>	0 - de-energize, 1 - energize, 2 - no action
High Alarm Relay List	<input type="text"/>	01 - 98
Relay High Alarm State	<input type="text"/>	0 - de-energize, 1 - energize, 2 - no action
Relay High to Normal State	<input type="text"/>	0 - de-energize, 1 - energize, 2 - no action
Relay Off on Acknowledge	<input type="text"/>	0 - do NOT de-energize, 1 - de-energize



# Digital Channels

Channel Number	<input type="text"/>	<input type="text"/>	11 - 98
Channel State (0)	<input type="text"/>	0 – Normally Open, 1 – Normally Closed	
Channel Message (1)	<input type="text"/>		
Channel Name	<input type="text"/>	<input type="text"/>	<input type="text"/>
Channel Mode (2)	<input type="text"/>	0 - 3	
Totalizer Limit	<input type="text"/>	<input type="text"/>	+/- 0 – 999,999,999
Duration Limit	<input type="text"/>	<input type="text"/>	+/- 0 – 999,999,999
Limit Reset Period	<input type="text"/>	<input type="text"/>	0 – 999999 minutes
Alarm Delay (3)	<input type="text"/>	<input type="text"/>	seconds
Continue Notify if Normal (4)	<input type="text"/>	0 – disable, 1 - enable	
Telephone List (5)	<input type="text"/>	01 - 16	
Low Alarm Relay List (6)	<input type="text"/>	01 - 99	
Relay Low Alarm State	<input type="text"/>	0 – de-energize, 1 – energize, 2 – no action	
Relay Low to Normal State	<input type="text"/>	0 – de-energize, 1 – energize, 2 – no action	
High Alarm Relay List	<input type="text"/>	01 - 98	
Relay High Alarm State	<input type="text"/>	0 – de-energize, 1 – energize, 2 – no action	
Relay High to Normal State	<input type="text"/>	0 – de-energize, 1 – energize, 2 – no action	
Relay Off on Acknowledge	<input type="text"/>	0 – do NOT de-energize, 1 – de-energize	

# Relay Channels

Channel Number	<input type="text"/>	<input type="text"/>	11 - 98																
Pulse Duration(0)	<input type="text"/>	<input type="text"/>	<input type="text"/>	seconds															
Channel Mode(2)	<input type="text"/>	<input type="text"/>	0 – disable, 1 – status only (enabled)																
Channel Name (4)	<input type="text"/>	<input type="text"/>	<input type="text"/>	<input type="text"/>	<input type="text"/>	<input type="text"/>	<input type="text"/>	<input type="text"/>	<input type="text"/>	<input type="text"/>	<input type="text"/>	<input type="text"/>	<input type="text"/>	<input type="text"/>	<input type="text"/>	<input type="text"/>	<input type="text"/>	<input type="text"/>	<input type="text"/>

# Relay Lists

Relay List Number	<input type="text"/>	<input type="text"/>	01 - 98
Position 1 Relay Channel (1)	<input type="text"/>	<input type="text"/>	11 - 98
Position 2 Relay Channel (2)	<input type="text"/>	<input type="text"/>	
Position 3 Relay Channel (3)	<input type="text"/>	<input type="text"/>	
Position 4 Relay Channel (4)	<input type="text"/>	<input type="text"/>	
Position 5 Relay Channel (5)	<input type="text"/>	<input type="text"/>	
Position 6 Relay Channel (6)	<input type="text"/>	<input type="text"/>	
Position 7 Relay Channel (7)	<input type="text"/>	<input type="text"/>	
Position 8 Relay Channel (8)	<input type="text"/>	<input type="text"/>	
Position 9 Relay Channel (9)	<input type="text"/>	<input type="text"/>	

# Index

abort phone call.....	61
access code .....	35, 36, 61
accumulated time .....	61
ACK key .....	61, 88
acknowledge alarms.....	33, 61, 69, 77, 79, 87, 88
input channel .....	33, 61, 76
Acknowledging alarms	
activate relay .....	32
AK .....	27, 61
AL.....	27, 61
alarm	
acknowledge.....	33, 69, 77, 79, 87
acknowledge locally .....	33
acknowledge remotely .....	33
alarm calls.....	62
alarm code.....	62, 65
alarm delay .....	40, 42, 62
alarm mode 0 .....	19, 63
alarm mode 2 .....	40, 63, 68
alarm mode 3 .....	40, 64, 68
alarm mode 4 .....	19, 40, 64, 68
alarm screen.....	27, 31, 64, 77
alarm state.....	55, 64, 90, 91
alarm types.....	65
Alarm(s)	
acknowledging .....	62
alarms	
presented .....	27
Alarms	
acknowledging .....	62
alphanumeric pager.....	1, 28, 62, 65, 85, 86, 87
analog input .....	8, 11, 17, 18, 39, 52, 53, 65
offset factor .....	66, 76
scaling factor .....	66, 76
wiring .....	12, 13
arm.....	34, 36, 70, 85
arm/disarm .....	34
audio settings .....	66
Backup battery	
"Battery is bad" message .....	66
battery	
backup .....	3, 7, 16, 66
channel .....	29, 53, 66, 72, 74
baud rate .....	47, 50, 66
between call delay.....	38, 67, 75
bksp key .....	22, 67
call in acknowledge .....	23, 33, 38, 67
call on limit .....	42, 67, 72
call progress.....	38, 67, 85
delay .....	38, 67
caller ID .....	67
cancel phone call.....	67
cell phone.....	1, 38, 85
channel	
analog conversion.....	65, 67, 90
battery.....	29, 53, 72
communication .....	29, 68, 84, 89
message .....	19, 68
mode.....	40, 41, 42, 68
name .....	17, 29, 65, 68, 90, 91, 92
names .....	25, 40, 41, 42
numbering .....	30
numbering Modbus .....	30
phone .....	29
primary power.....	29, 53, 66, 72, 77, 78, 89
relay .....	17, 79, 81, 84
state.....	17, 42, 68, 70, 91
system fault .....	29, 53, 76, 85, 89
temperature .....	29, 53, 84, 86, 89
clear key .....	68
CM .....	27, 62, 68
communication	
channel.....	29, 68, 84, 89
error .....	27, 62, 68
continue alarm notification if return to normal.....	69
datalogging.....	59, 69
date/time.....	35, 69
day.....	69, 73, 86
decimal position .....	39, 65, 67, 69, 73, 74, 87, 90
de-energize on alarm acknowledge .....	69
delay	
disarm to arm .....	34, 70, 85
program to run .....	78
diagnostics port .....	69, 83
DiaLogOnline.....	69, 77, 84
digital input .....	9
disabled .....	17, 68, 70, 73, 76, 77, 86
disarm.....	34, 36, 70, 85
disarm delay .....	34, 36, 70, 85
display .....	21
dry contact.....	70
duration limit.....	42, 61, 65, 67, 70, 72, 84, 91
duration Limit .....	42, 61, 67, 70, 84, 91
earth ground .....	6
engineering units .....	17, 35, 39, 65, 67, 71, 78, 90
Enter (#) key.....	71
enter text.....	25, 40, 41, 42
event log.....	1, 34, 59, 72
external DC power .....	7
firmware version .....	36, 72
flow	
totalized .....	65
full scale.....	17, 19, 39, 52, 53, 65, 67, 72, 90
fuse.....	7
global option .....	73
grounding .....	6
headphone connection .....	73
HI .....	27, 62, 73
high limit.....	28, 40, 63, 64, 68, 73, 89, 90
holiday calendar list .....	73
HOME key .....	61, 67, 73
Hyperterminal .....	1, 59, 69
input type.....	17, 73
Installation.....	3
keypad	
blue keys .....	22, 24
green keys .....	22, 24
programming keys .....	23
red keys.....	22, 24
LED	

amber.....	65	phone setup .....	38, 77
blinking .....	67	PLC .....	1, 45, 79
green.....	28, 73	port mode .....	57, 74, 77, 83
green blinking.....	28	positive rate of change.....	40, 77, 84, 90
red .....	28, 79	power fail .....	66, 77
red blinking .....	28	power switch .....	7, 14, 16
yellow.....	28, 87	press any key to continue .....	23, 77
yellow blinking.....	28	primary list start time .....	77, 78
limit reset period.....	42, 67, 70, 73, 78, 87, 91	primary phone list .....	77, 78, 82
listen in .....	74	primary power channel.....	29, 53, 66, 72, 77, 78, 89
LO.....	27, 62, 74	PROGRAM Mode.....	78
low battery .....	66, 74	program to run delay .....	78
low limit.....	28, 40, 63, 74, 89, 90	programming	
max idle .....	47, 50, 74, 75	calling in .....	23
max timeout .....	47, 50, 74, 75	from PC.....	57
message repeat .....	38, 62, 74, 76	locally .....	24
Message Repeats.....	62	Programming	
Modbus		shortcut keys .....	23
register number.....	46, 79	pulse Counting .....	78
register type .....	46, 47, 79	pulse Duration.....	17, 41, 78, 92
Modbus Master.....	45, 74	rate of change.....	40, 75, 77, 78, 79, 90
channel numbers.....	30	period.....	40, 75, 77, 78, 79, 90
channel setup.....	46	positive.....	40, 77, 84, 90
port setup.....	47	delay .....	79
slot.....	74, 75	redial after ack delay .....	79
Modbus Slave .....	2, 45, 47, 49, 50, 51, 68, 74, 75, 77, 83	register number.....	46, 79
ID29, 31, 47, 50, 68, 74, 81, 83		register type.....	46, 47, 79
modem call .....	75	relay.....	17, 43, 79, 80, 81, 84
modem setup.....	75, 76	activate.....	32
modify all settings		relay list.....	43, 80
for all channels .....	73	relay output .....	17, 79, 81, 84
for all phone numbers.....	73	relay output .....	14
negative rate of change .....	2, 40, 75, 79, 84, 90	relay state from high alarm.....	80
NEMA 4X enclosure .....	4	relay state from low alarm.....	80
normal state.....	2, 27, 28, 70, 80, 87	relay state to high alarm .....	80
normally open/closed.....	75, 88	relay " state to low alarm.....	80
notify once .....	38, 75, 85	remote relay control .....	79, 81
numeric ID.....	36, 75, 85	repeat interval.....	81
open loop .....	29, 85	reset counters.....	36, 81
limit .....	76	reset key .....	81
operating		reset to system defaults .....	36, 81
external DC power.....	7	ring count .....	23, 36, 81
power.....	3, 6	RS-485 .....	45, 47, 50, 68, 74, 81
temperature.....	3	RTU.....	1, 2, 27, 29, 45, 49, 81
Options		RUN Mode.....	26, 31, 76, 77, 82
menu.....	47, 50, 76	scaling value.....	78, 82
setup .....	24, 74, 76, 83	scr1.....	27, 82
pager .....	2, 28, 65, 75, 76, 86, 87	secondary list start time .....	78, 82
panel mount enclosure .....	4	secondary phone list.....	38, 82
phone		serial port.....	49, 57, 66, 69, 74, 77, 83
channel .....	29	sign.....	65, 83
number .....	81, 86	slave ID .....	46, 50, 83
Phone		slot number.....	83
ring count .....	23, 36, 81	speaker volume.....	36, 83
phone channel .....	76	speakerphone.....	23, 83
phone check .....	76	start time.....	59, 83, 86
phone fault .....	77	status code	
phone list .....	20, 38, 40, 42, 62, 73, 79, 82, 85, 86, 90, 91	acknowledged .....	27, 61
number .....	77	alarm .....	27, 61
position.....	77	communication .....	27, 62, 68
primary .....	77, 78, 82	high alarm .....	27, 62, 73
schedule.....	73, 82, 86	low alarm .....	27, 62, 74
secondary.....	38, 82	status notification schedule .....	83
secondary start time.....	78, 82	status only .....	29, 40, 41, 42, 68, 72, 84

status report.....	59, 75, 83, 84
system delays.....	36, 85
system fault	
channel .....	29, 53, 76, 85, 89
system ID.....	18, 36, 65, 76, 85
temperature	
channel .....	29, 53, 84, 86, 89

temperature channel .....	86
text entry .....	25, 40, 41, 42
text pager call.....	87
totalized flow.....	65, 71
totalizer .....	42, 65, 67, 72, 78, 82, 84, 87, 91
voice ID.....	85, 87
zero scale.....	17, 39, 65, 67, 87, 90



---

***Antx, inc.***

P.O. Box 200816  
Austin, TX 78720  
512/255-2800  
512/255-8306 (fax)

[www.antx.com](http://www.antx.com)